



**ENERGY BEST PRACTICES GUIDE:**

# **WATER & WASTEWATER INDUSTRY**



**focus on energy<sup>sm</sup>**

Partnering with Wisconsin utilities

# Water & Wastewater Industry Energy Best Practices Guidebook

**Brought to you by:**



This guidebook in whole is the property of the Public Service Commission of Wisconsin, and was funded through Focus on Energy.

Focus on Energy, Wisconsin utilities' statewide program for energy efficiency and renewable energy, helps eligible residents and businesses save energy and money while protecting the environment. Focus on Energy information, resources and financial incentives help to implement energy efficiency and renewable energy projects that otherwise would not be completed.

©2016 Wisconsin Focus on Energy

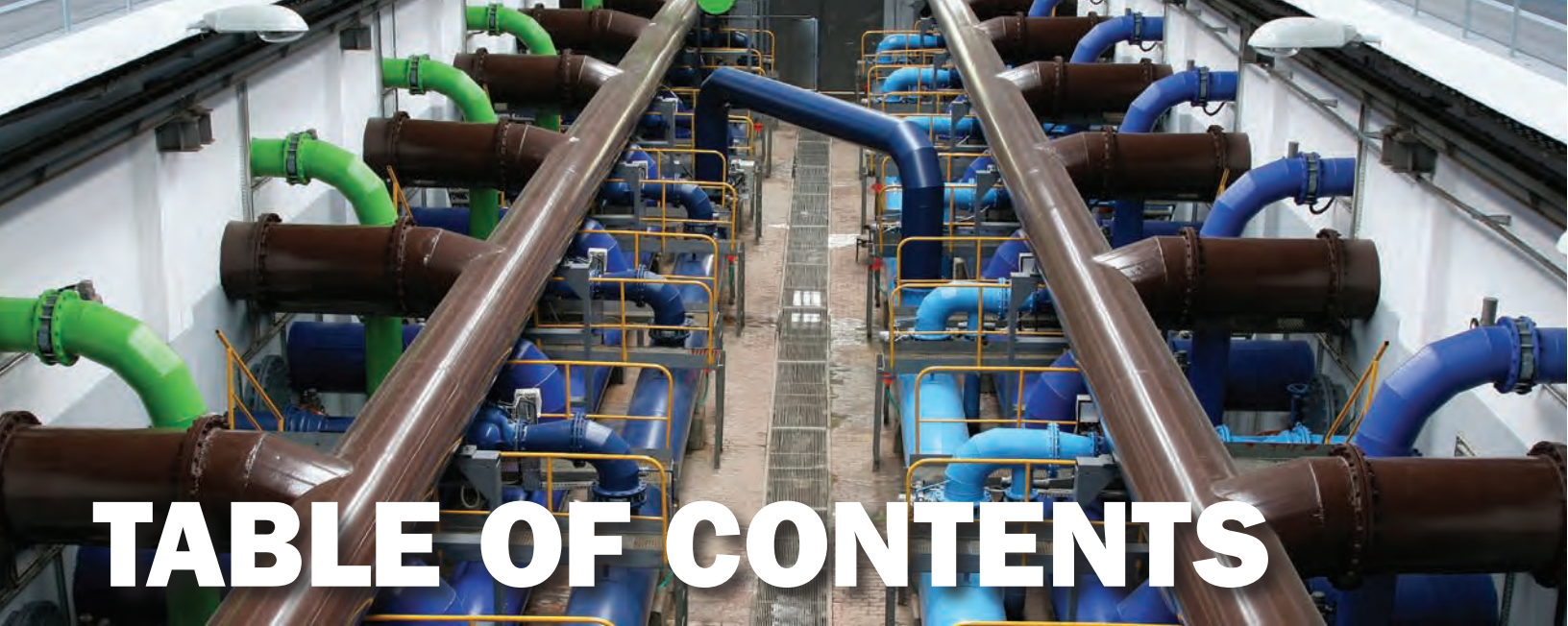

# TABLE OF CONTENTS

## INTRODUCTION

Energy Use in Water Treatment and Distribution Systems .....	6
Energy Use in Wastewater Treatment and Collection Systems .....	7
Energy Baseline .....	11
Energy Benchmarks .....	12

INTRODUCTION

## ENERGY MANAGEMENT

Program Development .....	15
Understanding Goals .....	15
Building a Program .....	16
Basic Steps in Building an Energy Management Program .....	17
Constraints .....	30

ENERGY MANAGEMENT

## BEST PRACTICES

General .....	31
Water Treatment .....	75
Wastewater .....	91
Buildings .....	133

BEST PRACTICES

## APPENDIX

Baseline Energy Use and KPI .....	149
Understanding Your Electric Bill .....	155
Economic Evaluation Process .....	161
Small Utility Energy Management Checklists .....	167
Additional Resources .....	179

APPENDIX

THIS PAGE INTENTIONALLY LEFT BLANK

# EXECUTIVE SUMMARY



The objective of this guidebook is to provide information and resources to assist water/wastewater facility management and staff in identifying and implementing opportunities to reduce energy use. This guidebook will help managers, administrators, and operators identify opportunities to significantly reduce energy requirements at facilities without affecting production. It also provides users with information on the value and need for proactive energy management of water and wastewater systems.

The goal of the Focus on Energy Business Programs is to help Wisconsin's non-residential energy utility customers save energy and money while protecting the environment. Focus on Energy provides information, resources, and financial incentives to help implement energy efficiency projects that otherwise would not be completed. To learn more about Focus on Energy offerings, call 800.762.7077 or visit [www.focusonenergy.com](http://www.focusonenergy.com).



## INTRODUCTION

The primary goal of the water and wastewater industry has always been environmental stewardship to meet all applicable water quality standards. The industry has focused on earning and maintaining public trust by protecting the health and welfare of its communities. For this reason, new, innovative and alternative technologies are approached cautiously within the industry. Likewise, incorporating energy efficient technologies and concepts into treatment processes is usually not a priority. This challenge is often compounded by a general lack of knowledge about energy use and energy billing. Energy costs are sometimes viewed as uncontrollable – a business cost that cannot be questioned or changed. However, if operation and management personnel become familiar with how their facility uses energy and is billed for it, they can find ways to manage and reduce energy costs.

The Focus on Energy Water and Wastewater guide was developed to support the industry because of the industry's enormous potential to reduce energy use without compromising water quality standards. Through the program, water and wastewater personnel have learned that energy use can be managed, with no adverse effects on water quality. Most locations that have implemented energy saving practices have also found improved control and treatment as an additional benefit. The improvements are often economically attractive, compared to their industrial counterparts, water and wastewater facilities typically see shorter paybacks on energy efficiency projects due to longer hours of operation. These facilities are necessary public infrastructure and therefore, have stable financial commitment for longterm viability.

# Energy Use in Water Treatment and Distribution Systems

Wisconsin consumes almost 400 million kilowatt hours per year to produce drinking water (about \$34.1 million)<sup>1</sup>. Wisconsin's 581 drinking water systems, like their wastewater counterparts, vary greatly in size and process components. The 98 largest systems account for nearly 79 percent of the energy used to treat water in Wisconsin, while the remaining 481 small facilities use nearly 21 percent. On average, water treatment facilities spend 11 percent of their operating budgets on energy, according to the American Water Works Association Research Foundation (AwwaRF)<sup>2</sup>. The table below presents the average energy use rates<sup>1</sup> for the various classes of drinking water utilities in Wisconsin. It should be noted that one-fourth of Wisconsin's drinking water utilities use less than 1.58 kWh per 1000 gallons<sup>1</sup>.

**Table 1 Energy Use Rates at Drinking Water Utilities**

Type	kWh/1000 Gallons
Class AB (> 4,000 customers)	1.81
Class C (1,000 - 4,000 customers)	1.94
Class D (< 1,000 customers)	2.41
Surface water source (WI)	2.16
Groundwater source (WI)	2.01

<sup>1</sup> Wisconsin State Energy Office. (2015, November). *Municipal Water Utility Benchmarking Analysis*. Retrieved from WI SEO website <http://www.stateenergyoffice.wi.gov/category.asp?linkcatid=3890&linkid=1844&locid=160>.

<sup>2</sup> *Manager's Guide for Best Practices for Energy Management*, AwwaRF, 2003.



The magnitude of energy savings available will vary depending on the type of treatment and delivery system in use, the age and condition of the equipment in use and the capital available to implement major changes, if necessary. Surface water treatment systems typically have more available energy savings since they require more equipment for treatment and have extended hours of operation compared to groundwater treatment systems. However, both types of water treatment systems have the potential to save significant amounts of energy, largely due to the aging infrastructure of the industry. It is not unusual to find 40 and 50 year old pumps, motors and controls that are still in use. Over 90 percent of energy consumed in producing and delivering drinking water is used for pumping.

Factors such as aging infrastructure, well recharge, well maintenance, well draw-down, local water quality and national/local security are likely to increase the need for improved treatment technologies, such as ozonation, membrane filtration and ultraviolet irradiation. These technologies are typically more energy intensive than conventional treatment. It is essential to address energy efficiency in the planning and design of new plants and equipment.



## Energy Use in Wastewater Treatment and Collection Systems

Wisconsin has approximately 650 public and 360 private wastewater treatment facilities. A summary of the public facilities' sizes is presented in Table 2 below. Wisconsin has many small facilities, approximately 85 percent of all facilities treat less than one million gallons per day (MGD). Though they treat only 12 percent of the total flow, these numerous small facilities use about 24 percent of the total energy needed to treat wastewater in the state, making them excellent candidates for energy efficiency projects. The remaining facilities, which all treat over one MGD, process 88 percent of the wastewater. Because of their sheer size, even simple energy efficiency projects at these larger facilities can lead to tremendous savings.

**Table 2** Flow Profile of Wisconsin Wastewater Facilities

MGD	Number of Facilities	% of Facilities	Cumulative %	% of Avg. Design Flow	Cumulative %	Total Avg. Design Flow MGD
0 - 0.25	402	61.8	61.8	3.7	3.7	33.7
0.26 - 0.5	93	14.3	76.1	3.8	7.5	35.3
0.51 - 1.0	55	8.5	84.6	4.1	11.6	38.0
1.01 - 2.0	34	5.2	89.8	5.7	17.3	52.0
2.01 - 5.0	37	5.7	95.5	12.2	29.5	112.1
5.01 - 10.0	11	1.7	97.2	8.2	37.7	75.5
10.01 - 20.0	11	1.7	98.9	18.0	55.7	165.5
20.01 - 50.0	5	0.8	99.7	18.6	74.3	171.4
> 50	2	0.3	100	25.7	100	236
Total	650	100		100		919.5

What is most important to utility managers is that, “Nationally, the energy used by the municipal water and wastewater treatment sector accounts for 35 percent of a typical municipality’s energy budget.”<sup>1</sup> However, what is more important to wastewater utility managers is, “Electricity constitutes between 25 and 40 percent of a typical wastewater treatment plant’s (WWTP’s) operating budget.”<sup>1</sup>

For another useful comparison, Table 3 shows the average energy use intensities for different types of wastewater treatment. Activated sludge treatment is broken down by flow range (MGD), and for each flow range the energy use intensity is indexed by millions of gallons of flow per day (MGD) and by biological oxygen demand (BOD) as a Key Performance Indicator (KPI). Because the cost of operating a wastewater facility is born by ratepayers, the energy intensity by population is also shown for comparison.

**Table 3 Average Energy Use at Wisconsin Wastewater Facilities\***

Treatment Type	Flow Range (MGD)	Number of Facilities Surveyed	kWh per Million Gallons	kWh per 1,000 lb of BOD	kWh per 1,000 Population Equivalent
Activated Sludge**	0 -1	26	5,440	3,178	242,032
	1 - 5	14	2,503	1,426	88,465
	> 5	11	2,288	1,505	93,365
	All AS	51	3,954	2,258	162,934
Aerated Lagoon	0 - 1	15	7,288	4,232	262,569
Oxidation Ditch	0 - 1.2 <sup>a</sup>	19	3,895	3,696	229,316

<sup>1</sup> *Statewide Assessment of Energy Use by the Municipal Water and Wastewater Sector - New York State Energy Research and Development Authority, November 2008.*

\* *The sample of facilities surveyed by Focus on Energy was not randomly selected and is not necessarily representative of all state facilities. The sampling included facilities that participated in Focus on Energy.*

\*\* *“Activated sludge” refers to diffused aeration, as differentiated from aerated lagoons and oxidation ditches which also rely on activated sludge treatment.*

<sup>a</sup> *Eighteen of these facilities are under 0.7 MGD; the remaining facility was at 1.2 MGD.*



Figures 1 and 2, as follows, show process flows for small and large wastewater systems. The **Energy Management** section discusses how to profile energy use at a facility, based on equipment energy usage.

Figure 1

## Small Wastewater System Process Flow Diagram

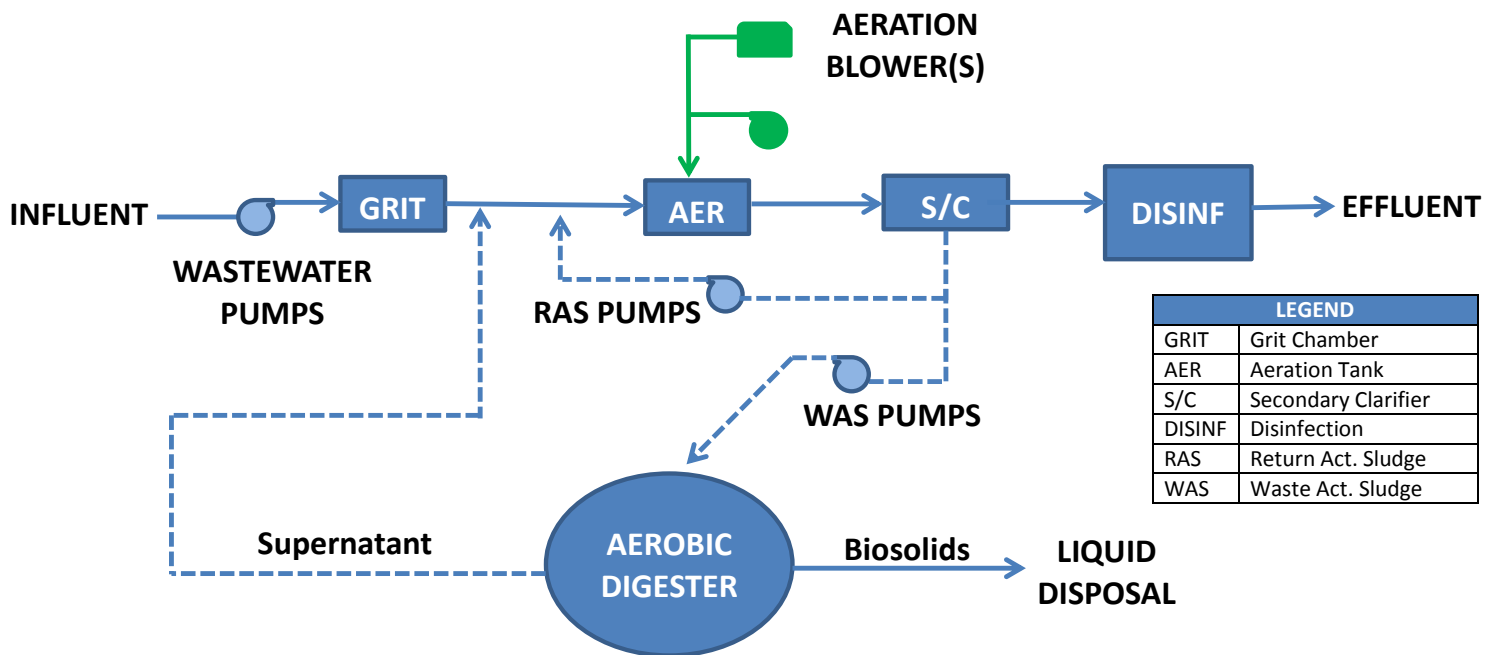
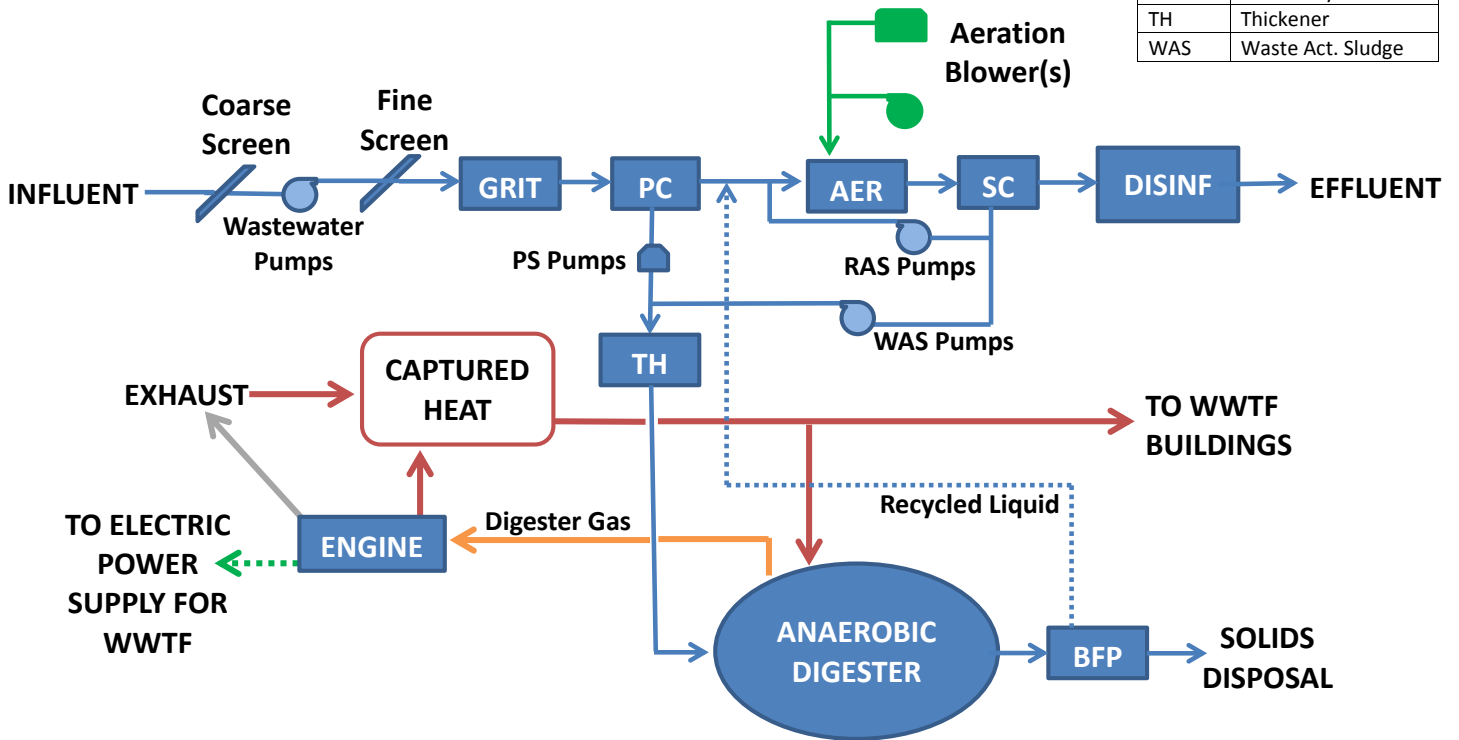

Figure 2

## Large Wastewater System Process Flow Diagram

LEGEND	
AER	Aeration Tank
BFP	Belt Filter Press
DISINF	Disinfection
GRIT	Grit Chamber
PC	Primary Clarifier
PS	Primary Sludge
RAS	Return Act. Sludge
SC	Secondary Clarifier
TH	Thickener
WAS	Waste Act. Sludge



# ENERGY BASELINE



For any type of facility, baseline energy use is the actual energy use under current operating conditions for a given period of time, such as a year. For purposes of comparison, a baseline is usually measured **before** new best practices are implemented. Baseline energy use can be measured both at the specific process level and at the entire system level. Energy baselines can be measured at different levels of operation and can be derived from energy bill data. When an energy improvement measure is completed, the new usage can be compared directly with the previous baseline usage to determine energy savings.

Many water and/or wastewater utility managers index their facility's energy usage through a production or demand index, such as kWh/MGD or kWh per 1,000lb of Biological Oxygen Demand (BOD). This index is called a Key Performance Index (KPI) or Energy Performance Index (EPI). Establishing an energy baseline helps facility managers understand the relative efficiency or change in efficiency relative to the core purpose of the operation, i.e., water production or wastewater treatment.

Figure 3 illustrates a water utility's KPI tracking relative to their goal. The baseline (previous year's average, by month) is represented by green bars and an annual average is represented by a red line. If the utility sets a goal to save five percent of its energy after it has implemented energy efficiency measures, a new annual average line (blue) is set as the targeted KPI level.

Figure 3

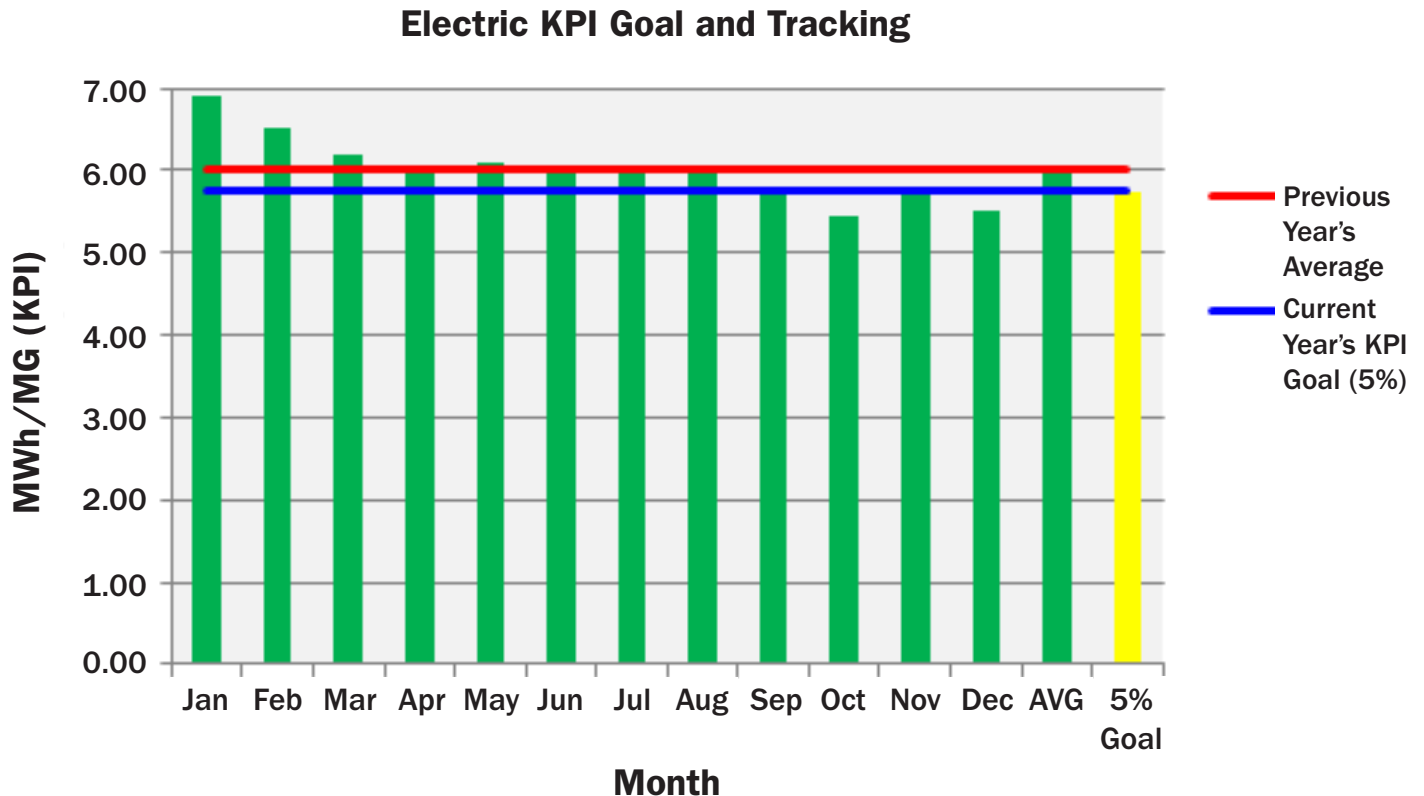



# ENERGY BENCHMARKS

An energy benchmark is an energy use target that a facility could achieve through the implementation of energy efficiency measures. There are many different types of benchmarks or targets for energy use, such as the energy use of the best 25 percent (or top quartile) of all facilities.

**Benchmarking** is a term commonly used by energy managers. It has a variety of meanings. For the purposes of this guidebook, the following definition from the American Water Works Association (AWWA) is considered useful:

“A **benchmark** is something that serves as a standard by which others may be measured or judged.”

A special type of benchmark is a **best practice benchmark**. Once a facility assessment has been completed to review the existing equipment and operations, a best practice benchmark can be estimated by subtracting the recommended best practice energy savings from the current energy use. Focus on Energy performed an assessment of the sample facilities and determined the energy savings from applying best practices. Subtracting the average best practice energy savings from the average energy use values for each facility type and flow range provides the **Best Practice Benchmarks** found in Table 4A for the three most common wastewater treatment types in Wisconsin. The values in the far right column show the amount of savings attainable from best practices, expressed as a percent.

**Table 4 Best Practice Benchmarks and Top Performance Quartiles for Wisconsin Wastewater Facilities**

Facility Type	Flow Range (MGD)	Average Energy Use (kWh/MG)	Top Performance Quartile (kWh/MG)	Best Practice Benchmark (kWh/MG)	Average Potential Savings
Activated Sludge**	0 -1	5,440	< 3,280	3,060	44%
	1 - 5	2,503	< 1,510	1,650	34%
	> 5	2,288	< 1,350	1,760	23%
Aerated Lagoon	< 1	7,288	< 4,000	3,540	51%
Oxidation Ditch	< 1.2	6,895	< 4,000	4,320	37%

The table also shows the Wisconsin wastewater industry **top performance quartiles**, in terms of current energy use. The top quartile values seen here represent considerable improvements over the industry average for each facility type. Using the industry’s top performance quartile as a target is another way to approach energy efficiency planning. When facility operators compare their energy use with the average and top quartile values, they can see how their facility compares with that of peers. Once an energy management plan is established, the facility operator can track performance improvement.

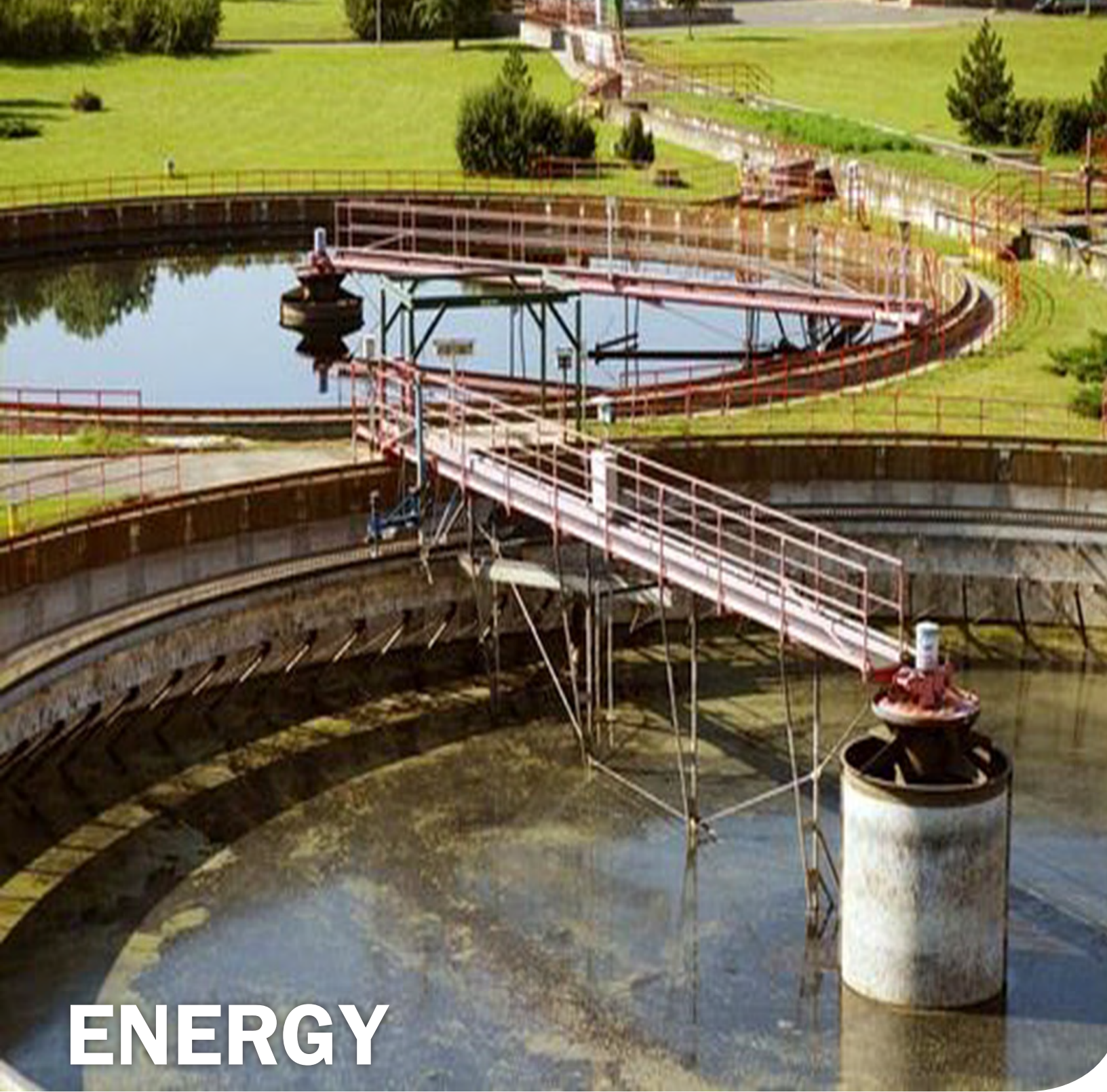

# ENERGY MANAGEMENT

THIS PAGE INTENTIONALLY LEFT BLANK

## PROGRAM DEVELOPMENT



Energy management program development goes beyond lowering on-peak demand and improving energy efficiency. Water and wastewater utilities should incorporate a broad range of energy management goals including:

- Improving energy efficiency to reduce the facility's total energy cost
- Learning how and when the facility uses energy
- Minimizing fee/rate impacts by controlling peak electric demand
- Managing systems when there is energy cost volatility
- Improving the efficiency and effectiveness of the operations that serve the utility's core mission
- Striving for energy neutrality when opportunities exist
- Implementing cost-effective renewable energy

Water and wastewater utilities are tasked with minimizing the costs associated with protecting water resources while maintaining a high degree of reliability. The goals listed above consider both the costs associated with energy consumption and the reliability of high-quality water over time. A good energy management plan needs to balance these goals according to their feasibility and the priorities of the utility.



## UNDERSTANDING GOALS

The goals of an energy management program often overlap with other best practices for utility management. For example, an effective preventive maintenance program can improve motor efficiency and system reliability. Computerized maintenance programs can also contribute to the achievement of energy management goals if they provide specific information about equipment, such as motor size and equipment capacity, which can be used in profiling facility energy use. Preventive maintenance can be scheduled to indicate when equipment needs to be replaced, ensuring that adequate time will be available to assess energy efficiency options.

Programming can include energy benchmarking at the facility level. The data can enable the tracking of specific end uses, as well as the overall facility energy usage, as it relates to water and wastewater treatment. Energy benchmarks based on output, for example gallons of water treated per kilowatt hour of electricity consumed, can give the utility a better sense not only of its overall usage trends, but also how its energy efficiency investments perform over time. Specific results from improvements, such as leak detection and repairs to the water distribution system, or reducing infiltration and inflow in wastewater collection systems, can be seen.

The implementation of energy management practices can also have additional beneficial effects, such as:

- Improved treatment
- Lower maintenance
- Increased equipment life
- Reduction in chemical consumption
- Lower utility surcharges
- Improvement in staff communications and morale
- A better understanding of treatment processes

These ancillary benefits should be considered when evaluating prospective energy management opportunities.

Understanding energy cost as it relates to usage is critical in managing energy at a utility. To do so requires a full understanding of the energy utility rate structure relative to quantity of usage and time of use. Water and wastewater treatment are intrinsically energy intensive, due to the need to move large volumes of water using pumps and electric motors and then treat that water to attain increasingly higher quality standards. The cost of the electricity used in treatment processes is based on two main components: the quantity and demand level of electricity used. The profile of equipment use at a facility and the real-time demand of treatment, whether it is for purifying community water supply or for treating wastewater, will have significant bearing on the ability of a facility to manage its energy usage.

## BUILDING A PROGRAM



This section outlines a nine-step approach to developing an effective energy management program. This approach will ensure a systematic process to document, analyze, and support energy related decisions that both the Energy Team and stakeholders can understand.

Most options for reducing energy use involve some commitment of resources, typically a capital investment or a modification to standard operating procedures. Trade-offs among various values can make investment decisions difficult, underscoring the need for a diverse, representative Energy Team. Specifically, a team that can evaluate the trade-offs from a variety of perspectives to ensure that none of the utility's primary goals are compromised by the proposed changes. High-quality energy use information allows the team to evaluate the benefits and costs, tangible and intangible, and fully address the facility's priorities in the decision-making process.

When pursuing the goal of system-wide energy efficiency, it is imperative to continually monitor and assess where additional energy efficiency can be achieved. Energy management is a continuous effort, requiring long term support. Furthermore, as changes to effluent requirements ensue, facility managers must continually be vigilant to make sure that the least amount of energy is being used to meet permitted effluent limits.

Each of the nine steps are described in more detail on the following pages.



## Basic Steps in Building an Energy Management Program



## STEP 1 ESTABLISH ORGANIZATIONAL COMMITMENT

While this may seem simple, this step may be the most critical to the success of the Energy Management Plan. In addition to approving and supporting the formation of an Energy Team, this step ensures that projects will be able to advance to implementation. Successful energy management requires a focused, coordinated, and empowered effort. Effective energy management begins at the top, and requires a champion who can rally the organization in support of an Energy Team's decisions. All power must flow from management into an Energy Team charged with achieving energy efficiency and renewable energy goals.

### KEYS TO SUCCESS:

- Understand the value of system-wide energy efficiency
- Identify and secure management support
- Establish and communicate measurable, long-term, energy goals

## STEP 2 ASSEMBLE AND INITIATE AN ENERGY TEAM

This step focuses on building a solid Energy Team that is comprised of key stakeholders. Representatives must be committed to supporting longterm energy management. Because energy use cuts across many organizational boundaries, a diverse team that understands the wide array of issues around energy management needs to be in place. While the specific level of effort required from different team members may vary over time, it is essential to maintain involvement, commitment, and support from each team member.

Municipalities and industries should assemble an Energy Team that represents as many stakeholders as possible, including management, administration, accounting, compliance, operation, and maintenance. The integration of all of the disciplines into the team allows for input from all business and operational perspectives, and distributes the responsibility of achieving the goals.

The team must also seek and maintain the support of management, so it can continue to be empowered to take actions necessary to guide the facility toward energy plan implementation.



## **ASSEMBLE AND INITIATE AN ENERGY TEAM (CONTINUED)**

An Energy Team is responsible for:

- Profiling energy use
- Identifying and evaluating opportunities
- Establishing attainable energy goals
- Prioritizing and selecting projects
- Procuring the resources necessary to make each project successful
- Measuring project impacts
- Reporting impacts and results to management

A strong Energy Team, backed by management, will help to resolve many of the organizational barriers to improving energy use. In some facilities the operations staff is never involved in evaluating energy procurement decisions and may never see energy bills. This lack of awareness of the impact of energy usage on production is counter-productive not only to the achievement of energy efficiency goals, but to fiscal responsibility as well. In an effective energy management model, a cross-functional Energy Team helps to improve communication between the business group and the operations staff, reinforcing the connection between energy use and energy procurement. To start this step, an Energy Team could invite an elected official, such as the mayor; a manager at the treatment plant; an operator; or a member of the finance department to join their team. In cases where changes to energy management practices will result in facility design modifications, the appropriate regulatory agency could also be invited.

### **AN ADVANCED ENERGY TEAM WILL:**

- Consist of representatives of each critical stakeholder.
- Set a reasonable schedule for meeting that takes advantage of early momentum.
- Develop an Energy Management Plan (EMP). This plan should establish the overall mission and document the organization's commitment to achieving system-wide energy efficiency goals. Details of the plan, including scheduling and assignments, will be added as the team gains a better understanding of needs, resources, and opportunities through initial investigations.
- Establish performance goals, metrics, and incentives. This task includes establishing benchmarks and targets, and identifying ways to measure changes in performance indicators, as well as ways to encourage support of these efforts. This also includes establishing a communication plan to define how information will be shared, assigning tasks, and setting a schedule of milestones and deadlines.
- Define resource needs. Utility management should demonstrate a commitment to the team by allocating resources to achieve the stated goals. The team will be responsible for identifying resource needs such as staff time, equipment, external consulting support, and budget. Resource requests should be balanced by projected energy benefits with respect to core functions.
- Assign responsibilities and tasks to team members and support staff as needs are identified.
- Serve as an energy information clearinghouse. The Energy Team should be a utility-wide resource that provides information about energy use and coordinates communications about any projects that affect energy use. For example, recommendations from the Energy Team should be coordinated with the capital improvement planning process and annual maintenance program.

## KEYS TO SUCCESS

- Achieve management support and participation
- Attain cross-functional representation
- Allocate adequate resources (time, staff, budget, expertise)
- Establish performance indicators that will demonstrate progress
- Communicate intent to all employees

## STEP 3

### DEVELOP A BASELINE OF THE FACILITY'S ENERGY USE

This step focuses on gathering readily available energy use information and organizing that information into a basic model that can help utilities to understand energy use patterns and communicate findings. The model can be as simple as plotting energy bills over time (e.g., total kWh by day or month) or as complex as listing all of the major energy-using processes, obtaining a power draw for each specific process, and, based on the times of operation, estimating process and system off-peak and on-peak energy use. An example of a simple approach is presented in Appendix A.

In this step, facility personnel will collect the data needed to provide an energy baseline, or starting point, against which future energy use will be compared. This will be especially useful to assess the energy impact of new projects, including non-energy ones. The data should be relatively easy to collect, such as that obtained from existing metering, and should be time-labeled. Baseline data should include production data, such as millions of gallons per day (MGD) supplied or pounds per day (ppd) of Biochemical oxygen demand (BOD) treated, along with the corresponding demand and energy usage.

Based on the facility's goals, the Energy Team will need to identify a way to measure success in terms of energy usage. The measure of success, or **Key Performance Indicator (KPI)**, will be expressed in production units, such as *kilowatt-hours per unit of flow*. By tracking the KPI over time, facility personnel will be able to detect any changes in energy usage per unit of output that are due to changes in activities or equipment.

Each time an intervention is made, such as the installation of new equipment, the time should be recorded on the time line of the tracked data so that the impact of the energy improvement can be seen and quantified. For example, the installation of a new aerator may reduce a wastewater treatment facility's KPI from 3,500 kWh per million gallons (MG) to 2,200 kWh per MG. For the most accurate results, the energy use data on individual pieces of equipment should also be collected and tracked individually (see Step 4). The data can then be assembled into systems for analysis of the complete treatment process system. Tracking KPIs can also show changes in operational characteristics, influent or effluent flow, and weather. It can even show how energy usage changes with new equipment or facility additions.

## **DEVELOP A BASELINE OF THE FACILITY'S ENERGY USE (CONTINUED)**

An Energy Team should focus on improving the understanding of where, when, and why energy is used within a water/wastewater system and include it in their Energy Management Plan (EMP). Studies have demonstrated that even the process of investigating energy use and improving awareness among staff can provide measurable energy efficiency savings ranging from three to five percent.

### **AN ADVANCED ENERGY TEAM WILL:**

- Collect and organize data on equipment, energy use, energy costs, hydraulic loading and organic loading. At a minimum, one year of data should be analyzed to identify any seasonal patterns. Three or more years of data would be ideal for discovering trends and anomalies over time. Data sources can include utility billing records, supervisory control and data acquisition (SCADA) system records, O&M records, and equipment/motor lists with horsepower and load information. Regulatory agency water quality reporting records providing hydraulic and waste strength characteristics may also be useful.
- Develop an understanding of where, when, and why energy is used. Organizing treatment processes by functional area will facilitate energy planning and management on a process level, and will also make performance measurement and baseline development easier.
- Evaluate energy bills and understand the energy rate structure. Many energy management strategies are directly linked to the pricing of energy; and it is critical to understand how the energy rate structure affects energy costs and which specific rate structure applies. It may also be possible to select from other options. Reaching out directly to the power utility account manager for additional assistance in understanding available rate structures may help. Reviewing and understanding the electric bill is critical in accomplishing this step of the process. Appendix B explains a typical utility bill for a wastewater treatment facility of any size in Wisconsin.
- Assess the relationships between hydraulic loading, organic loading, and energy use. Hydraulic data (i.e. flow) and organic loadings should be assembled to analyze the correlations between flow, organic loading, and energy use. Analyze data at several time frames to identify diurnal patterns, seasonal patterns, the effects of wet and dry weather, average daily flows, and energy demand.
- Build a basic energy use model, based on a conceptual understanding of the utility operation, to organize data and capture energy use patterns. In the early stages of energy management, typical models can be created using a generic spreadsheet. Larger utilities should consider purchasing specific software for organizing energy data. The level of modeling sophistication can range from a basic motor list providing horsepower and energy demand (kW) to a time-varying (dynamic) model that predicts hourly demand and energy costs. The process of modeling can help to identify the most helpful types of information, the limitations on currently available information, and what data needs to be gathered. In addition, an energy use model can be a valuable tool for testing theories, validating an understanding of energy use, calculating performance metrics, and visualizing and communicating energy use patterns.
- Create basic graphics and reports to communicate initial findings. Although this step occurs early in the process, it can produce some valuable insights that should be shared with a wider audience, including systems management, administration, and operation and maintenance personnel.

## KEYS TO SUCCESS

- Begin with simpler tasks and gradually increase the complexity of the information gathered to match goals, needs, and resources
- Use initial findings to organize and justify future, more detailed information gathering

## STEP 4

### DEVELOP PROFILES OF ENERGY USAGE FOR MAJOR EQUIPMENT TYPES

Whereas the development of the initial energy-use baseline derives from historical records, this step relies on collecting data for current operations that can be used in tracking energy usage. The facility manager should know which end-uses in the operation, such as pumping or specific treatment processes, consume the most energy. A full profile of energy use with respect to end use should be developed. A typical distribution of energy use per process can be seen in the example below.



## DEVELOP PROFILES OF ENERGY USAGE FOR MAJOR EQUIPMENT TYPES (CONTINUED)

One useful tactic for gaining a better understanding of energy use is to interview supervisory, operations, and maintenance staff. Interviews can help to verify understanding of energy use, identify limitations to future actions, and provide helpful suggestions for energy projects.

### AN ADVANCED ENERGY TEAM WILL:

- Perform system walk-through assessments to verify equipment lists, size and capacity of equipment, operating status, and motor sizes for major unit treatment systems.
- Conduct staff interviews. Use these interviews to build understanding of operating practices, maintenance practices and history, regulatory and engineering limitations, and operational priorities. In addition, collect suggestions for energy efficiency project opportunities.
- Gather energy performance data. Fill gaps in the energy model with field data. This may include direct measurements using a power meter, tracking average equipment run times of motors throughout the day, or using a more sophisticated sub-metering system to gather actual energy use and time of use data.
- Track energy performance by equipment process. The data from the various end use systems can be applied to understanding the overall facility KPI discussed in Step 3. Furthermore, if an equipment process contributes significantly to total energy use, it may be worthwhile to develop an individual baseline and process performance index (ppi) for that specific process. One example of this is kWh per Pumps A, B, and C (daily, monthly, annual). The ppi could be accompanied by a load shape showing peak and average demand (kW). Another example could be kWh per Aerators X, Y, and Z, as a function of influent BOD. Since processes are additive components of the overall system, including more processes in tracking will improve the understanding of what contributes to system performance. Once baselines, KPIs, and equipment performance characteristics are obtained for the system and key processes, the performance of energy projects can be measured and tracked. Performance metrics can be compared with historical data or engineering design criteria, or can be used for benchmarking that compares performance with peer facilities (see Step 7).
- Update the energy use model, detailing it with equipment-specific data. Make any improvements and/or corrections in the energy use model using newly gathered field data and observations. This may include refining assumptions such as the loadings or times of use for various motors and other equipment.

### KEYS TO SUCCESS

- Use energy baseline results (Step 3) to discover and prioritize field efforts on the most promising opportunities, such as large motors and energy-intensive processes. It may be economical to collect field data only for the largest equipment. Approximations may be an acceptable alternative to field data for smaller systems and motors.



## STEP 5

### IDENTIFY AND ASSESS PROJECT OPPORTUNITIES

Achieving system energy efficiency requires consideration of both energy efficiency and renewable energy opportunities. While efficiency reduces energy consumption, renewable energy enables the system to utilize available “free” energy from the system, including solar, wind, and biogas. Each opportunity must succeed on the basis of its own cost-effectiveness with respect to the system’s specific needs and both types of projects should be considered, side-by-side, when making energy project investment decisions.

Begin by utilizing the data profile to identify energy project opportunities and prioritize them in the context of the overall business and regulatory priorities of the utility. If the expertise to analyze the opportunities does not exist in-house, consider hiring an external expert who can develop a list of priorities and implementation plan.

An energy efficiency opportunity can be any system change (equipment or operations) that reduces energy consumption or power demand. A renewable energy opportunity can be any usage of available energy from the wind, sun, or biogas that can displace purchased energy. In this stage, the Energy Team will identify a list of energy efficiency opportunities with the intention of evaluating and prioritizing them according to feasibility and cost-effectiveness. Ideas for energy efficiency may come from a variety of sources, including reference materials, success stories from similar water/wastewater systems, interviews with staff, consultant recommendations, or discussions with energy providers or energy efficiency program advisors. Categorizing energy efficiency opportunities, such as by process area or by funding approach, can help to organize a large amount of information into a manageable format. Examples of categories for organization include:

- Capital program versus equipment replacement
- Process (aeration, pumping) versus ancillary technology (lighting, HVAC, etc.)
- Operational change (a change in the sequence or the way operations are done by facility personnel)
- Automation or controls
- Maintenance improvements
- Business case analysis results

#### AN ADVANCED ENERGY TEAM WILL:

- List and categorize best practice opportunities, focusing on large equipment and processes where the greatest savings opportunities exist
- Investigate similar projects implemented at peer facilities
- Discuss energy efficiency opportunities with external experts, such as utility account representatives, energy efficiency program providers, and other external consultants
- Rank projects based on business case analysis results (payback, life cycle cost, ROI, etc.)

#### KEYS TO SUCCESS

- Complete a list of energy project opportunities
- Consider the relationship of each listed opportunity to the Energy Team’s stated goals
- Focus, initially, on the larger system opportunities while including a wide array of energy efficiency opportunities
- Consider renewable energy opportunities, as well as energy efficiency, that will be cost-effective and make sense for the system



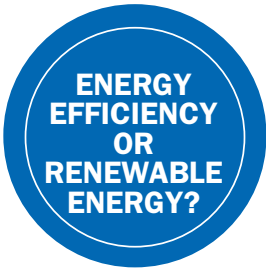

## ATTAIN ENERGY NEUTRALITY

Is it better to save energy or to produce it? The goal of attaining energy neutrality can be incorporated into any system's Energy Management Plan. Many water and wastewater utilities have already moved toward this goal by utilizing both energy efficient and renewable energy options.

## BECOME ENERGY EFFICIENT

The trade-offs between energy efficiency and renewable energy development are often complex. Generally, a water/wastewater utility will focus its efforts first on becoming as energy efficient as is practicable, making sure that all of its processes and end uses are as "trim" as possible. Generally, placing emphasis on energy efficiency before renewable energy projects makes sense, because when a system's energy usage footprint is minimized, it becomes easier to meet the remaining energy needs with internally-generated renewable energy resources. However, technical issues, including an opportunity to take advantage of a new construction digester project, may warrant the utility's consideration of biogas utilization technology before an energy efficiency improvement.

## ASSESS THE SITUATION

In the normal sequence of project development, once energy efficiency has been achieved at a facility, the next step is to assess the feasibility of renewable energy options. A variety of renewable sources are available: solar, wind, hydro, and biogas, among others. Each source should be assessed, site-specifically, for feasibility and life-cycle cost. A combination of renewable resources may even be appropriate for a site. For example, a combination of solar and biogas may be appropriate: a solar system can offset some energy requirements during the daylight hours and a biogas system can offset the energy requirements during the evening hours or on cloudy days.

## FIND THE RIGHT FIT

Each renewable resource can be assessed for what may best fit its system requirements in terms of technical feasibility and cost-effectiveness. In the case of municipal utility systems, since there is little risk of going out of business even in a declining economy, the utility experiences the luxury of being able to justify longer project paybacks. However, at the same time, the municipal utility system is obligated to serve utility ratepayers who are subject to variations in the economy.



## STEP 6

### PRIORITIZE OPPORTUNITIES FOR IMPLEMENTATION

The final product of this step is a short, prioritized list of energy projects that have been carefully evaluated for energy savings benefits from the list of opportunities generated in Step 5. This short list of prioritized energy projects should be based on both the water/wastewater system's business priorities and the ability of the projects to meet the utility's stated energy goals. As identified and evaluated by the cross-functional Energy Team, the listed projects must be economically viable and able to be implemented with minimum risk or conflict.

Prioritizing energy projects may be difficult when comparing the goals and risks of different, competing projects. In this step, the Energy Team will compare the various benefit and cost trade-offs. Whenever possible, a benefit-cost test should be applied to prioritizing projects. The utility system will also apply its own economic evaluation methods, such as payback, return on investment, or life cycle cost, to prioritize energy projects. A discussion and examples of these economic evaluation methods are available in Appendix C.

Any complete evaluation of options must also consider intangible effects, such as risk to compliance or the potential impact on the health and safety of workers. Assigning a dollar value to benefits, such as reducing the risk of process failure or improving operator safety, can be challenging. In such cases, it may be necessary to develop more specialized evaluation criteria.

#### AN ADVANCED ENERGY TEAM WILL:

- Evaluate the **monetary** characteristics of the proposed energy projects. Choose appropriate evaluation methods, quantify the benefits and costs, convert all costs into equivalent terms, and tally the results
- Identify suitable evaluation criteria to compare the benefits and costs of non-monetary features of the proposed energy projects
- Combine the non-monetary and monetary values. Score and rank the benefits and costs of each proposed project, and organize the summary evaluation into a presentable format for communication
- Ensure that the final results make sense with respect to the utility's overall capabilities and mission. Implementing energy projects should not undermine a utility's capacity to implement necessary changes with respect to production or compliance

#### KEYS TO SUCCESS

- Convert all benefit-cost criteria into monetary terms whenever possible (monetary terms are easy to compare and communicate)
- Evaluate all energy goals and including ancillary benefits whenever possible



## STEP 7

### DEVELOP AND IMPLEMENT THE PLAN

This step ensures that the Energy Management Plan reflects the priorities of the stakeholders and is effectively executed to realize energy benefits. The plan will include specifications for projects, a schedule for completion, a budget, task assignments, and expected results based on previous analyses. The plan will show any relationships of energy projects to each other, as well as to existing processes, potential shut-downs or other changes in routine schedules, and any risks to performance of core activities. Tracking and reporting mechanisms will be put in place to report results once the projects are installed and operational.



Ultimately, any implemented project must demonstrate an impact on the utility's overall energy performance, with respect to its designated Key Performance Indicator. The Energy Management Plan can help forecast the change in KPI based on evaluations conducted prior to installation.

One useful tool that a utility may use to gauge performance of its energy projects is benchmarking. Benchmarking is a process that is similar to baselining for an individual utility, except that it averages the energy performance across a sampling of peer facilities. A benchmark can be used as a reference point for measuring an individual facility's performance with respect to other similar facilities with the same types of processes and operations. Beginning with its own energy baseline, the Energy Team may want to include a water or wastewater energy benchmark as it sets its goals. See Appendix A for more information on benchmarks at typically-sized water or wastewater utilities.

Steps 4, 5, and 6 helped to identify and prioritize energy project opportunities. This step focuses on implementation.

## **AN ADVANCED ENERGY TEAM WILL:**

- List the energy project opportunities selected for implementation and clearly describe the objectives of each
- Indicate the resources needed, including time, staffing, budget and financing plan.
- Discuss any associated production factors, including technical risks
- Develop and procure any specifications needed, including design criteria and procurement-related documents
- Identify any expected changes in standard operating procedures and/or process control strategies
- Develop a schedule for implementation, including milestones and the procurement of the necessary regulatory approvals (if applicable)
- Set realistic expectations for the project(s) in terms of resource procurement, scheduling, anticipated production impacts, energy impacts, and forecast benefit-cost.
- Tie forecast impacts to the Key Performance Indicator

## **KEYS TO SUCCESS**

- Describe clear, measurable project objectives, including benefits, costs, and risk abatement
- Receive authorization for the requested resources, including budget and contractor approvals
- Establish a reasonable schedule for implementation



## **STEP 8**

### **TRACK AND REPORT PROGRESS**

The success of a selected project should begin to be measured upon installation. Measurements should focus on performance metrics, including the status of the installation schedule as well as the resulting impacts on energy usage, operations, maintenance, process performance, staff attitudes and productivity. Tracking provides historical documentation of patterns, trends, and the impacts of project interventions. Depicted graphically, they can show dramatic results arising from Energy Team efforts. Results of performance monitoring should be communicated to stakeholders, including anyone involved in the planning process, the Operations and Maintenance (O&M) staff responsible for implementation, and utility management.

Often overlooked, this step is critical to sustaining an energy management program. It provides insight into making necessary adjustments to improve performance, guidance for future decision-making, and motivation for staff to continue on course and achieve goals.

## **AN ADVANCED ENERGY TEAM WILL:**

- Establish the appropriate performance metrics
- Find or create a reasonable benchmark that can serve as a performance target with respect to KPI

- Assign responsibility and allocate resources for tracking and reporting the progress of a project
- Create a communication plan that specifies what should be reported, to whom progress reports are delivered (such as elected officials, utility personnel, staff, media, or the public), when the reports should be delivered, and any follow-up actions that may be required

## KEYS TO SUCCESS

- Use reliable, measurable performance metrics
- Follow up on data analysis, e.g. investigating when data appear irregular or celebrating when success is indicated



## STEP 9

### CONTINUALLY UPDATE PLAN TO ACHIEVE ENERGY MANAGEMENT GOALS

As lessons are learned and progress is made toward achieving the Energy Management Plan's goals, the Energy Team will want to adjust the plan to reorder priorities, procedures, and assignments to ensure the long-term plan is a success. The Team should employ a continual improvement process by identifying and refining new project opportunities and adjusting the implementation plan according to changing needs.

The previous steps have presented how to develop an Energy Team, develop your energy baseline, identify energy projects, implement energy projects, and measure and promote their value. This step is a reminder that energy management is not a one-time action and needs to be embraced as a continuous and ever-changing process, so that it becomes a seamless part of the business practice of the utility. The water/wastewater industry in general should continue to move forward in its quest to implement energy efficiency and renewable energy, both in retrofits and in new designs.

Over time, needs and priorities for a utility system will change. This may be in large part due to the impact that energy projects have had on the system, as well as a variety of external factors, such as regulations or the economy. In addition, the system operators will learn valuable lessons over time regarding team dynamics, project development, and communications.

### AN ADVANCED ENERGY TEAM WILL:

- Monitor the impacts of projects on the system and determine results
- Learn where there have been successes or failures, so that future adjustments can be made
- Monitor the Key Performance Indicator and process performance indices to look for additional improvements
- Reset goals and tasks as circumstances require

## KEYS TO SUCCESS

- Use the KPI to identify irregularities and successes
- Recognize shortcomings and adjust accordingly
- Maintain motivation through acknowledgment and celebration



## CONSTRAINTS

Most engineering decisions have to be made within the context of a larger business plan, which requires determining all of the impacts of proposed projects, showing a benefit-cost analysis, and identifying those projects with the most promising benefits, with respect to all departments within a utility. Comprehensive awareness and understanding of all concerns and issues are requirements for good energy planning, management, and decision-making.

Typical constraints on an Energy Management Program include the following:

- Organizational constraints
- Capital costs
- Process reliability
- Acceptance of modifications by facility personnel
- Regulatory requirements, approvals, and limits
- O&M capabilities and non-energy O&M costs
- Engineering feasibility
- Space availability

While effective energy management remains a very important goal, projects should not undermine design limitations or compliance with regulatory requirements. Site characteristics and all of the variables that influence project selection (labor, chemical costs, disposal costs, capital costs, etc.) may render even the most energy efficient solution or renewable energy project infeasible.



# BEST PRACTICES

## GENERAL

THIS PAGE INTENTIONALLY LEFT BLANK





# GENERAL BEST PRACTICES

## PLANNING AND MANAGEMENT

- |           |   |         |
|-----------|---|---------|
| <b>G1</b> | Appoint an Energy Manager   | Page 37 |
| <b>G2</b> | Utilize and Manage Monitored and Recorded Data                        | Page 38 |
| <b>G3</b> | Manage Electric Rate Structure  | Page 39 |
| <b>G4</b> | Include Energy Efficiency in Capital Improvement and Operations Plans | Page 40 |
| <b>G5</b> | Let Energy Efficiency Pay for Itself                                  | Page 41 |
| <b>G6</b> | Use Life-Cycle Cost Analysis for Purchase Selection                   | Page 43 |
| <b>G7</b> | Design Flexibility for Today and Tomorrow                             | Page 44 |

## ASSESSMENTS

- |           |                             |         |
|-----------|-----------------------------|---------|
| <b>G8</b> | Facility Energy Assessments | Page 45 |
| <b>G9</b> | Pump Station Assessment     | Page 47 |

## MONITORING AND CONTROLS

- |            |  |         |
|------------|--|---------|
| <b>G10</b> | Real-Time Energy Monitoring                      | Page 49 |
| <b>G11</b> | Supervisory Control and Data Acquisition (SCADA) | Page 50 |

<b>G12</b>	Electric Peak Reduction	Page 51
<b>G13</b>	Filtration: Sequence Backwash Cycles	Page 53
<b>G14</b>	Idle or Turn Off Equipment	Page 54

## **EQUIPMENT MEASURES**

<b>G15</b>	Electric Motors: Properly Maintain Motors	Page 55
<b>G16</b>	Electric Motors: Correctly Size Motors	Page 56
<b>G17</b>	Electric Motors: Install High Efficiency Motors	Page 58
<b>G18</b>	Electric Motors: Variable Frequency Drive Applications	Page 60
<b>G19</b>	Electric Motors: Automate to Monitor and Control	Page 62
<b>G20</b>	Electric Motors: Improve Power Factor	Page 63
<b>G21</b>	Pumps: Optimize Pump System Efficiency	Page 64
<b>G22</b>	Pumps: Reduce Pumping Flow	Page 66
<b>G23</b>	Pumps: Reduce Pumping Head	Page 67
<b>G24</b>	Pumps: Avoid Pump Discharge Throttling	Page 68
<b>G25</b>	Ultraviolet (UV) Disinfection Options	Page 69
<b>G26</b>	Incorporate Energy Efficiency in Membrane Treatment Systems	Page 71

## **EDUCATION AND INFORMATION**

<b>G27</b>	Energy Efficiency for Facility Personnel	Page 73
<b>G28</b>	Ensure Plant Personnel Receive and Understand Monthly Energy Bills	Page 74

# General Best Practices



The following table shows the typical energy savings and payback periods for the Best Practices found in this section, grouped by category, and includes three blank columns for you to complete as you analyze each practice. You can utilize this checklist to track the process of reviewing these Best Practices and note which ones are feasible for your utility and which ones need further review.

Best Practices	Typical Energy Savings of Unit of Process (%)	Typical Payback Years	Best Practice Feasible? (Yes/No)	Date Analyzed	Further Review Needed? (Yes/No)
<b>Planning and Management</b>					
G1 - Appoint an Energy Manager	Variable	Variable			
G2 - Utilize and Manage Monitored and Recorded Data	10 - 20	Variable			
G3 - Manage Electric Rate Structure	Variable	Variable			
G4 - Include Energy Efficiency in Capital Improvement and Operations	Variable	0.5 - 5			
G5 - Let Energy Efficiency Pay for Itself	Variable	Variable			
G6 - Use Life-Cycle Cost Analysis for Purchase Selection	Variable	Variable			
G7 - Design Flexibility for Today and Tomorrow	Variable	1 - 5			
<b>Assessments</b>					
G8 - Facility Energy Assessments	10 - 50	Variable			
G9 - Pump Station Assessment	20 - 50	Variable			
<b>Monitoring and Controls</b>					
G10 - Real-Time Energy Monitoring	5 - 20	Variable			
G11 - Supervisory Control and Data Acquisition (SCADA)	Variable	Variable			
G12 - Electric Peak Reduction	Variable	< 1			
G13 - Filtration: Sequence Backwash Cycles	Variable	Variable			
G14 - Idle or Turn Off Equipment	Variable	< 1			

Best Practices	Typical Energy Savings of Unit of Process (%)	Typical Payback Years	Best Practice Feasible? (Yes/No)	Date Analyzed	Further Review Needed? (Yes/No)
<b>Equipment Measures</b>					
G15 - Electric Motors: Properly Maintain Motors	Variable	Variable			
G16 - Electric Motors: Correctly Size Motors	Variable	Variable			
G17 - Electric Motors: Install High Efficiency Motors	5 - 10	< 2			
G18 - Electric Motors: Variable Frequency Drive Applications	10 - 40	0.5 - 5			
G19 - Electric Motors: Automate to Monitor and Control	Variable	Variable			
G20 - Electric Motors: Improve Power Factor	Variable	Variable			
G21 - Pumps: Optimize Pump System Efficiency	15 - 30	0.25 - 3			
G22 - Pumps: Reduce Pumping Flow	Variable	Variable			
G23 - Pumps: Reduce Pumping Head	Variable	Variable			
G24 - Pumps: Avoid Pump Discharge Throttling	10 - 50	Variable			
G25 - Ultraviolet (UV) Disinfection Options	Variable	Variable			
G26 - Incorporate Energy Efficiency in Membrane Treatment Systems	Variable	Variable			
<b>Education and Information</b>					
G27 - Energy Education for Facility Personnel	Variable	Variable			
G28 - Ensure Plant Personnel Receive and Understand Monthly Energy Bills	Variable	Variable			

## G1 — APPOINT AN ENERGY MANAGER

Water and/or wastewater utilities should identify and appoint an energy manager. The duties and responsibilities of the position should be defined according to the needs of the utility. This position, where practical, should be full-time. If possible, the position should have the authority and budget for improving the energy efficiency of the existing system. The energy manager should also be responsible for making sure that all new construction and equipment upgrades are energy efficient from the start, and throughout the lifetime of the improvements.

See Also	Not applicable
Primary Area/ Process	This practice involves all components of water and wastewater systems.
Productivity Impact	No impact
Economic Benefit	Having an energy manager does not guarantee payback; however, an effective energy manager can produce significant returns on the investment. Payback on projects implemented as the result of having an energy manager will vary by project and may range from a few months to several years.
Energy Savings	Energy savings are derived from the incorporation of energy efficient equipment and practices in the capital and operational modifications that get implemented.
Applications & Limitations	No limitations
Practical Notes	The energy manager needs to have defined responsibilities and a budget in order to plan, develop, and implement new energy efficiency programs and projects.
Other Benefits	Additional benefits include a well managed energy budget and optimized energy utilization. The energy manager may also support energy related budget proposals before the governing commission.
Stages of Acceptance	Increasingly, utilities are seeing the value of having an in-house champion (energy manager) that can promote, integrate, and shepherd energy efficiency projects to implementation.

## G2 — UTILIZE AND MANAGE MONITORED AND RECORDED DATA

Water and wastewater system operators are encouraged to monitor and record facility/station data, including influent flow, biochemical oxygen demand (BOD), total suspended solids (TSS), ammonia, dissolved oxygen, kilowatt (kW) consumption, kW demand and therms. This data should be organized and managed so that it becomes a usable tool in managing both the operations and the energy usage of a water/wastewater system. The recorded data, represented by trend graphs and pie charts, provide a pictorial tool that can give insight into the operations, maintenance and administration of the system. For example, a trend graph of energy consumption versus influent flow can show the consistency or inconsistency of energy consumption with respect to operation. A similar plot of energy consumption versus organic load can be valuable in monitoring the impact of organic loading on a wastewater system. Recorded energy use data for each major piece of equipment can show load shapes and possible decay trends, making it invaluable for energy benchmarking and in finding energy efficiency opportunities.

### See Also

G8 – Facility Energy Assessment  
G10 – Real Time Energy Monitoring  
G12 – Electric Peak Reduction

### Primary Area/ Process

This practice should be applied across all water and wastewater systems.

### Productivity Impact

There should be no impact aside from a minor disturbance during the installation of equipment associated with the practice.

### Economic Benefit

The payback period will vary with the complexity of the installed data collection equipment and tools developed from the recorded data. Most of the value of this practice will be obtained by reducing and better managing energy consumption.

### Energy Savings

Savings will vary but can be in the range of 10 to 20 percent of the total energy consumed by the system.

### Applications & Limitations

There are few, if any, applications where data cannot be monitored, recorded and managed.

### Practical Notes

There is value in applying this practice to all water/wastewater systems.

### Other Benefits

Additional benefits include improved operation, water quality, and longer life for the equipment.

### Stages of Acceptance

Improved data management and its application to problem-solving is increasingly becoming an accepted practice in water and wastewater system management.

## G3 — MANAGE ELECTRIC RATE STRUCTURE

Facility management should work with the electric utility account manager to review the facility's electric rate structure. The review should determine if the current rate structure is the most appropriate pricing structure for the facility, based on peak demand and overall energy usage.

### See Also

G12 – Electric Peak Reduction

### Primary Area/ Process

This should be implemented facility-wide, with special attention to accounting and purchasing.

### Productivity Impact

No impact

### Economic Benefit

There is no direct return on investment for this practice. Nevertheless, actual process changes made in response to recommendations may result in economic benefits.

### Energy Savings

No direct savings. However, energy and power demand savings may be available if the facility can respond to the current electric rate structure.

### Applications & Limitations

All facilities should apply this practice.

### Practical Notes

All personnel should be aware of how their specific facility or department is charged for energy consumption and peak demand.

### Other Benefits

Management will give more attention to the operation of a system if an understanding of the electric utility rate structure is incorporated into daily operating procedures and information is made available to everyone.

### Stages of Acceptance

The practice of reviewing utility bills and rate structures is becoming more common as its value becomes recognized and personnel become more energy cost conscious.

## G4 — INCLUDE ENERGY EFFICIENCY IN CAPITAL IMPROVEMENT AND OPERATIONS PLANS

Facility management should incorporate all appropriate energy efficiency and renewable energy best practices into capital and operations improvement plans. This includes clearly defining system goals and objectives and setting the design criteria for system improvements. Including energy projects upfront in the design stages can avoid lost opportunities once the measure is installed. Correcting a design oversight after the fact can be costly.

See Also

Not applicable

Primary Area/  
Process

This process should involve all components of water treatment/distribution and wastewater treatment systems.

Productivity  
Impact

No impact

Economic  
Benefit

Payback will vary by facility size, type of treatment, and by project, depending on the energy benefits and costs of alternative designs and operations. Payback may vary from a few months to several years.

Energy Savings

Present and future energy savings are derived from the incorporation of energy best practices in the capital and operations improvement plans.

Applications &  
Limitations

There are no limitations on this practice because comprehensive planning, which includes energy project design, occurs prior to project development.

Practical Notes

Proactive and open communications promote the success of capital and operations improvement planning that includes consideration of energy projects and energy management. Combining energy efficiency measures into a capital improvement project and justifying them in the aggregate helps avoid lost opportunities for future energy savings. Energy saving improvements should always be evaluated on a life-cycle cost basis.

Other Benefits

Well-conceived and planned projects result in the highest value to the utility.

Stages of  
Acceptance

Increasingly, utilities are recognizing the value of project development and management. Its acceptance is growing, especially as a means to better manage limited budgets.



## G5 — LET ENERGY EFFICIENCY PAY FOR ITSELF

When analyzing the financial impact of an energy efficiency project, the utility should include the projected payback period, calculated on the basis of the energy savings. The inherent value of a good energy project is that it will eventually pay for its initial cost before it needs to be replaced.

The energy savings of an energy efficiency investment can be accounted for and used to offset the cost of repaying the loan used to fund the project. After the loan has been paid in full, the value of all energy savings accrues to the water/wastewater system. Since many projects pay for themselves in less than five years, a considerable amount of future net benefit is available to the water/ wastewater system for this investment.

When considering a given project and all associated costs (including payback range and projected energy savings), facility management will determine whether the payback period is within the reasonable range of acceptability.

See Also

Not applicable

Primary Area/  
Process

This practice should be applied to all projects that incorporate energy savings and/or peak demand reduction for a water or wastewater system.

Productivity  
Impact

No impact

Economic  
Benefit

Where the energy savings are applied to the repayment of a loan for the equipment, payback does not have to be considered as long as the repayment period is shorter than the lifetime of the equipment. Care should be taken to ensure that a reliable estimate of monthly savings is made, and the savings exceed the loan payment. The ultimate benefit is the present value of the stream of energy savings that accrue once the equipment loan has been paid.

Energy Savings

Energy savings will vary depending upon the equipment being installed.

Applications &  
Limitations

No limitations

## Practical Notes

While a treatment facility's accounting department can typically manage the loan structure for an energy efficiency investment, due diligence will require an estimate of energy savings from a reliable energy efficiency engineer. External resources, such as energy service companies, are also available to facilitate this type of loan agreement. A detailed assessment of the present operating conditions and proposed design conditions is necessary. The assessment should identify existing conditions, low-flow conditions, and proposed 20-year design conditions. The full range of operation should be considered when selecting

## Other Benefits

Under a properly structured loan, the facility experiences only positive cash flow, i.e., the energy savings exceed the loan repayment cost.

## Stages of Acceptance

This best practice is gaining acceptance as water/wastewater systems come to understand how energy savings can pay for even major investments.

## G6 — USE LIFE-CYCLE COST ANALYSIS FOR PURCHASE SELECTION

Facility management should utilize life-cycle cost analysis when assessing and purchasing equipment, rather than selecting equipment based on the lowest upfront cost. Life-cycle cost analysis incorporates the energy efficiency of the unit over the lifetime of the equipment.

Water and wastewater utilities, as regulated monopolies, often do not experience the same longterm risks of private companies that are subject to market economies. Since they are less exposed to economic conditions, they can usually consider long-term projects whose costs can be absorbed in rates over the equipment lifetime. This difference allows them to treat investment decisions on a life-cycle cost basis. This is especially important for energy efficiency projects since the present value of energy savings over the lifetime can often easily offset the initial capital cost of the energy efficiency improvement.

See Also	Not applicable
Primary Area/ Process	This best practice is applicable to all equipment purchases and new construction investments by water or wastewater facilities. It is particularly valuable when assessing large energy consumers and components that operate continuously.
Productivity Impact	This best practice has no impact on productivity. Investment costs are generally built into water/wastewater utility rates which ultimately affect customer costs.
Economic Benefit	Evaluating capital projects using life-cycle cost ensures that energy savings and total economic benefit are considered.
Energy Savings	Energy savings will vary depending on the extent of the improvement.
Applications & Limitations	None
Practical Notes	This best practice should be implemented for all purchases. An estimate of the equipment lifetime and an understanding of present value concepts, supplied by accounting professionals, can easily provide an estimate of life-cycle cost.
Other Benefits	Additional benefits of this practice include lower operating costs, more stable rates and lower long-term costs for ratepayers.
Stages of Acceptance	Life-cycle cost analysis is becoming more accepted, particularly where energy costs are high and constitute a major portion of a utility's budget.

## G7 — DESIGN FLEXIBILITY FOR TODAY AND TOMORROW

Operation, administration and management personnel should be involved with the planning and design of any improvement and/or expansion to their system. Design and expansion should have the flexibility to serve both current and future system needs. These processes should consider any significant anticipated changes, including energy usage.

See Also

Not applicable

Primary Area/  
Process

This best practice is applicable to all components of water or wastewater systems.

Productivity  
Impact

The impact should be negligible.

Economic  
Benefit

The selected design of any modifications, improvements, or expansions should reflect the highest quality at a reasonable cost. The simple payback for installing several smaller operating units that can manage current system demand, compared with a larger, single unit operating at reduced capacity, is usually one to five years. Flexible operation that allows for sequencing and incremental load management often has potential for energy savings.

Energy Savings

Energy savings will vary by project, but are directly related to a system's ability to follow demand at all points throughout the system's lifetime, compared with being designed only for 20-year peak flows.

Applications &  
Limitations

None

Practical Notes

Start by conducting an assessment of the size and space needed to install multiple smaller units, as compared to one or two larger units. Note that continuously operating smaller unit(s) will strain the system less than operating a larger unit periodically.

Other Benefits

Having a system that operates effectively and efficiently throughout the life of its design, not just at its future design condition, is a value to the system operations. A flexible operating system will also help manage power demand and avoid high billing peaks.

Stages of  
Acceptance

Designers and owners are becoming more knowledgeable and accepting of equipment sized to match existing conditions, as opposed to only considering projected peak design needs.

## G8 — FACILITY ENERGY ASSESSMENTS

An annual energy survey should be a common practice for all water and wastewater systems to identify and prioritize opportunities for improving energy efficiency and considering renewable sources. While the survey should assess major processes, it should also evaluate baseload end uses such as light and ventilation processes.

See Also

Not applicable

Primary Area/  
Process

This practice should examine the entire facility, emphasizing major processes such as pumping, aeration, disinfection, and solids management.

Productivity  
Impact

Minor disruption of production may occur in order to observe equipment operation during the survey.

Economic  
Benefit

A survey is conducted to identify opportunities for measures with payback, but it does not provide a payback itself. Payback periods vary with the modification recommended.

Energy Savings

A survey only identifies energy savings potential. The energy savings identified in an assessment of a treatment process will typically range from 10 to 50 percent of current usage, with some opportunities reaching 65 percent savings.

Applications &  
Limitations

None

Practical Notes

A survey can identify opportunities for energy savings at any facility, regardless of treatment process, facility age, or size.

Other Benefits

Taking a closer look at operations through a survey leads to greater awareness of energy use at all points of operation.

Stages of  
Acceptance

Many facilities are using energy surveys as the starting point for more rigorous energy management.

## Resources

The United States Environmental Protection Agency's (EPA) tool for benchmarking wastewater and water utilities is a multi-parameter energy performance metric that allows for comparison of energy use among water resource recovery facilities (WRRFs). The tool can be accessed through the EPA's ENERGY STAR® Portfolio Manager platform (see link below). Portfolio Manager is an interactive web based energy management system that allows building managers and water/wastewater operators to track and assess energy consumption and carbon footprint. Portfolio Manager is appropriate for primary, secondary and advanced treatment plants with or without nutrient removal. The tool is applicable to WRRFs that have design flows of 1 MGD or more. After inputting the following facility information into the Portfolio Manager platform, the tool produces an energy use "score" relative to the scores of a national population of WRRFs, expressed on a scale of 1 to 100. This score is determined using the following categories:

- Average influent flow
- Average influent biological oxygen demand (BOD5)
- Average effluent biological oxygen demand (BOD5)
- Plant design flow rate
- Presence of fixed film trickle filtration process
- Presence of nutrient removal process

The tool can be accessed at: <http://www.energystar.gov/buildings>.

## G9 — PUMPS: PUMP STATION ASSESSMENTS

Water and wastewater systems should develop an energy efficiency assessment of each of their pump stations. Design codes require a variety of flow rate conditions to be achieved. As a result, water/wastewater utilities select most pumps with the intent to meet peak-flow conditions. They also typically provide a redundant backup unit for emergencies or unforeseen peaks. This results in many pumps that are too large to be energy efficient for most of their daily operating loads.

When selecting pumps, the water/wastewater utility should consider current operating conditions or start-up low-flows. The utility should determine the power consumption of the pumping system (motor, drive, and pump) across the range of pumping rates, from current flow up to design flow. Measured data can be used to construct a pump performance curve for the installed system. The actual performance curve should be compared to the manufacturer's pump curve. This comparison will provide insight to the energy efficiency of the installed system, and support an analysis of savings that may be achieved if a motor, pump, or drive is added or changed.

Most water/wastewater pump stations can benefit from a variable speed drive or new or additional pump, selected on the basis of average and/or low-flow conditions.

### See Also

G21 – Pumps: Optimize Pump System Efficiency  
 G22 – Pumps: Reduce Pumping Flow  
 G23 – Pumps: Reduce Pumping Head  
 G24 – Pumps: Avoid Pump Discharge Throttling

### Primary Area/ Process

This best practice can be applied to all systems with active pump stations.

### Productivity Impact

There is minimal impact outside of the collection and recording of operating data.

### Economic Benefit

Payback will vary with each pump station assessed, with respect to size (HP), operating time, and schedule.

### Energy Savings

Energy savings will vary by project but can range from 20 to 50 percent of current pumping energy. Actual savings will depend on the types of changes being considered.

### Applications & Limitations

Applied to all pumping systems. No limitations.

### Practical Notes

A complete analysis is required before deciding which modification(s) to implement.

## Other Benefits

This practice can provide the facility with improved understanding of the condition of all of the components of the pump station. In addition, these modifications can potentially reduce wear and tear on the pumping equipment in the pump station.

## Stages of Acceptance

Assessing pump stations in water and wastewater systems is a readily accepted practice that is continually gaining more interest and implementation.



## G10 — REAL-TIME ENERGY MONITORING

An accurate, real-time energy monitoring system facilitates the collection and analysis of energy data for each treatment process and pump system at 15-minute intervals. Monitoring enables utility and management staff to develop energy consumption baselines for various end uses. From established baselines, staff can identify opportunities, set energy reduction goals, and monitor/verify results.

### See Also

Not applicable

### Primary Area/ Process

Monitoring technology can be applied to any process treatment system and is most beneficial for high-energy-consuming processes, especially those with variable loads.

### Productivity Impact

No impact

### Economic Benefit

Economic payback depends on the cost of the monitoring system and on the system's ability to help identify savings opportunities. Payback may also be affected if the monitoring equipment can control the system's operating parameters.

### Energy Savings

The achievable range of energy savings is typically 5 to 20 percent at facilities where energy efficiency is viewed as an ongoing function.

### Applications & Limitations

Each site must be individually assessed to identify which processes will benefit the most from monitoring.

### Practical Notes

The greatest barrier to implementation is acquiring management approval for the monitoring equipment. Facility managers should include the potential savings from energy management in the payback calculations needed to justify the investment.

### Other Benefits

Monitoring can also support other functions, such as load management, maintenance, and the identification of failing equipment.

### Stages of Acceptance

This measure is well known but not widely practiced, since it is usually not necessary for meeting system performance goals (effluent limits), nor is it required by design codes.

## G11 — SUPERVISORY CONTROL AND DATA ACQUISITION (SCADA)

Supervisory Control and Data Acquisition (SCADA) systems refer to the hardware and software systems that allow operators of distribution, collection, and treatment systems to remotely monitor field parameters and equipment operation, and to make adjustments to process parameters. SCADA systems provide the human-machine interface (HMI) that enables operators to interact more readily with the various electronic monitors and controls used in water and wastewater systems. SCADA can improve energy use tracking with routine energy “benchmarking,” through:

- Monitoring energy use over time, including comparisons with process variables or key performance indicators, such as flow rate, chemical use, pounds of BOD, and pounds of TSS
- Offsetting loads and controlling motor operating times to manage peak electric demand

### See Also

G19 - Electric Motors: Automate To Monitor and Control

### Primary Area/ Process

This practice affects a facility’s instrumentation and controls.

### Productivity Impact

The facility should expect minimum impact after installation. Control systems should also improve system performance.

### Economic Benefit

Payback varies significantly depending on the extent and complexity of the monitoring and control system installed.

### Energy Savings

Typically, energy savings result from the ability to match equipment performance to the real-time demands of the system.

### Applications & Limitations

The capital investment required to implement a SCADA system can be cost-prohibitive for some smaller utilities. Utilities that already use SCADA will incur additional capital costs for adding energy monitoring capabilities and developing energy benchmarking reports.

### Practical Notes

An understanding of energy consumption through monitoring and tracking can make energy management less complicated.

### Other Benefits

Use of a SCADA system for equipment and process control can benefit the entire water and/or wastewater system by highlighting problem areas.

### Stages of Acceptance

SCADA systems are widely accepted in the water and wastewater industry. Cost is often the greatest barrier to adoption.

## G12 — ELECTRIC PEAK REDUCTION

Management of peak demand (shifting to off-peak or shaving peak power usage) can substantially lower energy bill costs. The following can be done to optimize power use and reduce electric peak demand:

- Assess electric bills to understand demand charges and examine facility operations to determine ways to reduce peak demand. Ask your electric utility account representative for a 15 minute demand profile to better understand when your peak demand occurs.
- Develop an operation strategy that meets overall system demand and minimizes pumping and specific treatment processes during peak demand periods. Consider adding storage capacity or delaying the time of operation of non-critical treatment processes.
- Assess both the typical and peak operations of a water and/or wastewater system to identify areas where peak demand can be trimmed or shifted

### See Also

G3 - Manage Electric Rate Structure  
G14 - Idle or Turn Off Equipment

### Primary Area/ Process

All energy-using components of water and wastewater systems, with a focus on the supply side, are candidates for off-peak operation. For example, the following actions can be taken to reduce energy usage:

#### Water systems

- Pump at rates to meet water demand, avoiding peak power periods, where possible (refill storage tanks only when necessary)
- Ensure all storage tanks are full prior to peak demand periods
- Monitor on/off levels in storage tanks to reduce energy usage

#### Wastewater systems

- Operate sludge presses during off-peak times
- Shift recycling to off-peak periods
- Load or feed anaerobic digesters off-peak, so supernatant does not recycle during peak periods
- Operate mixers or aerators in aerobic digesters during off-peak times
- Accept or treat hauled-in wastes during off-peak times

### Productivity Impact

No impact

### Economic Benefit

Paybacks are typically less than one year because modifications are generally procedural and not expensive.

### Energy Savings

Energy use savings (kWh) are generally minor. Most savings result from reduced demand (kW) for peak power.

## Applications & Limitations

The application of this practice may be limited by the amount of storage available and the minimum power requirement for necessary operations. Substantial savings are more likely with a time-of-use (TOU) rate. Smaller facilities may not be charged separately for on-peak demand.

## Practical Notes

An understanding of the relationships between peak power demand and the demands of water supply and wastewater treatment are necessary to make this measure effective.

## Other Benefits

The benefits include an improved use of system components.

## Stages of Acceptance

Understanding electric usage helps customers manage their electric loads according to their specific electric utility rate structures. Most water and wastewater utilities are aware of this, but may not be optimizing operations to fit the rates.

## G13 — FILTRATION: SEQUENCE BACKWASH CYCLES

A filtration system can have high energy consumption and high peak power demand. The highest energy users in filtration systems are typically backwash pumps and the aeration blower if it uses an air-assisted backwash system. Operators should consider sequencing and shifting the backwash cycles to off-peak periods to reduce the electric peak demand. In some applications, it is possible to pump at a lower rate over a longer period of time to a water storage tank located at a higher elevation, and backwash using gravity flow. In addition, if the backwash system includes air-assist capabilities, the facility should determine if the blower size could also be reduced.

See Also

Not applicable

Primary Area/  
Process

Single media or multimedia granular or membrane filtration systems are applied to water systems and utilized in tertiary treatment in wastewater systems.

Productivity  
Impact

Productivity should not be impacted by the sequencing of backwash cycles. The primary concern should be ensuring availability of sufficient filtration capacity.

Economic  
Benefit

Savings will result from a lower peak electric demand due to the shifted and staggered operation of backwash pumps and/or an aeration blower.

Energy Savings

Energy savings (kWh) are generally minor. Utility bill savings result from reduced peak demand (kW).

Applications &  
Limitations

Backwashing during off-peak time can affect staffing needs and labor, as operators must be present.

Practical Notes

None

Other Benefits

Sequencing of backwash cycles provides a more stable and constant operation of filter units. Backwashing during electric off-peak times also provides an opportunity to treat the backwash wastewater during off-peak times.

Stages of  
Acceptance

Sequencing of backwash cycles is an accepted practice in both the water and wastewater industry.

## G14 — IDLE OR TURN OFF EQUIPMENT

Non-essential equipment should be idled or turned off, when feasible, especially during periods of peak power demand. Review operations and operating schedules to determine if any equipment is not required for the proper operation of the facility.

### See Also

G12 – Electric Peak Reduction

### Primary Area/ Process

This practice can be applied to almost all components in a water or wastewater system.

### Productivity Impact

No impact

### Economic Benefit

Paybacks are typically short, if not immediate, because only low or no-cost changes in operational procedures are involved.

### Energy Savings

Savings depend on the amount of nonessential equipment that is currently operating. If shut-off occurs during peak power demand periods, lower power demand charges will result.

### Applications & Limitations

Care must be taken not to turn off an essential component of the treatment process, monitoring equipment, or warning system. Provide as much automatic control, such as timers, as can feasibly be done in order to reduce the need for operator attention and the potential for operator error. This practice should not undermine compliance with design conditions and regulatory requirements.

### Practical Notes

Knowing why each piece of equipment is operating and if its operation is critical to the overall performance of the system at any given time may be valuable when trying to reduce peak power demand charges.

### Other Benefits

This practice can also result in increased equipment life, reduced maintenance, and possibly fewer spare parts required.

### Stages of Acceptance

Water and wastewater utilities are increasingly more willing to turn off equipment once they understand that system requirements can still be achieved.

## G15 — ELECTRIC MOTORS: PROPERLY MAINTAIN MOTORS

A regular program of preventive maintenance can increase motor efficiency and prolong service life. A typical maintenance program should include:

- Performance monitoring, i.e., periodic measurements of power consumed in comparison to an initial baseline
- Measurement of resistance provided by winding
- Insulation inspection (Megger testing)
- Proper lubrication of motor bearings
- Verification of proper motor coupling alignment, or belt alignment and tension
- Cleaning of cooling vents
- Maintenance of protective circuitry, motor starters, controls, and other switchgear
- Recording the hours of operation

See Also

Not applicable

Primary Area/  
Process

This practice should be applied to all electric motors.

Productivity  
Impact

This practice will have no effect except for a minimal disruption during motor maintenance.

Economic  
Benefit

The resources allocated for preventive motor maintenance should be balanced with cost considerations and expected benefits. Preventive maintenance will ensure performance to specifications and longer equipment life.

Energy Savings

The energy savings will depend on the status and operating conditions of the system, including the motor equipment.

Applications &  
Limitations

No limitations

Practical Notes

None

Other Benefits

Preventive maintenance benefits all processes in a water/wastewater system and reduces operation and maintenance costs.

Stages of  
Acceptance

Preventive maintenance of electric motors is a recognized best practice in the water and wastewater industry.

## G16 — ELECTRIC MOTORS: CORRECTLY SIZE MOTORS

The facility should select the proper size motor for each specific application, especially where load factors are relatively constant. Motors should be sized to run primarily in the 65 to 100 percent load range. In applications that require larger motors to meet peak process loads, alternative strategies should be considered, such as the use of a correctly sized motor backed up with a larger motor that only operates during process peak demand periods.

See Also

G17 – Electric Motors: Install High-Efficiency Motors

Primary Area/  
Process

This practice should be applied to all electric motors.

Productivity  
Impact

Minimal impact during installation

Economic  
Benefit

Savings will vary depending on motor size and application.

Energy Savings

Savings will vary depending on motor size and application.

Applications &  
Limitations

No limitations

Practical Notes

Many motors are larger than necessary for average loading conditions, thereby wasting energy when a smaller motor could be used. Oversized motors can also result in a lower power factor. Motors that are oversized by more than 50 percent should be replaced with correctly sized, high-efficiency or premium-efficiency motors.

Other Benefits

None

Stages of  
Acceptance

Not applicable





## Results

The Department of Energy has developed MotorMaster+, a popular motor selection and management tool. This free software includes a catalog of more than 25,000 AC motors and features motor inventory management tools, maintenance log tracking, predictive maintenance testing, energy efficiency analysis, savings evaluation capabilities and environmental reporting. The motor load and efficiency values are automatically determined when measured values are entered into the software. MotorMaster+ can quickly help water/wastewater systems identify inefficient or oversized motors and readily calculate the savings that can be achieved with more energy efficient models.

To download MotorMaster+, visit: <http://www.energy.gov/eere/amo/articles/motormaster>

## G17 — ELECTRIC MOTORS: INSTALL HIGH-EFFICIENCY MOTORS

Facility personnel should survey existing motors for possible replacement with new, premium efficiency motors and specify the most energy efficient motors on all new installed and inventoried equipment. The facility should establish an emergency motor replacement program that specifies energy efficient motors. As a backup measure facility personnel should, identify a local motor supplier that has an inventory of the most energy efficient motors for all process installation conditions.

### See Also

G16 - Electric Motors: Correctly Size Motors  
G18 - Electric Motors: Variable Frequency Drive Applications  
G19 - Electric Motors: Automate To Monitor and Control

### Primary Area/ Process

This practice can be applied to all electric motors, especially on well and booster pumps for water systems, on wastewater facility motors with high annual operating hours, and for those that operate during peak hours. These include aeration blowers, disinfection systems, pumps, and clarifiers.

### Productivity Impact

Facility operation managers should expect minor impact due to the brief shutdown for removal and replacement of the existing motor.

### Economic Benefit

The simple payback is generally short — often less than two years — if the motor operates continuously. However, if the equipment's annual hours of operation are minimal, the simple payback period may be longer.

### Energy Savings

Savings will range between 5 and 10 percent of the energy used by the motor being replaced.

### Applications & Limitations

The physical characteristics and ambient conditions of the existing motor must be considered when replacing a motor. For example, the new motor may have to be explosion-proof, spark-resistant, or have immersion capability (flooding conditions).

### Practical Notes

Typically, when an existing motor is replaced or needs to undergo major repairs, a premium efficiency motor is used. Often, such as under conditions of high annual operating hours, it may be worthwhile to replace a working motor. In any case, facility management should determine if it is economically justifiable to replace older motors instead of repairing them.

The size of the existing machine should be assessed to determine if it has the operating range to be energy efficient. Often a machine may be oversized to meet maximum design flow even if the system may never reach that flow. Adding a smaller machine to process average or low flow while keeping the large machine in place to meet maximum design flow requirements may be advantageous.

When planning a motor replacement, the project team should keep in mind that a premium-efficiency motor may require a longer delivery time than a standard or high-efficiency motor of the same size, and shouldn't allow adequate time in the project schedule.

Other Benefits

An additional benefit to this practice is a reduction in emissions from the power source (electric utility).

Stages of Acceptance

Energy efficient motors are a well-known, proven, and accepted technology.

## MOTOR LIFE-CYCLE COST

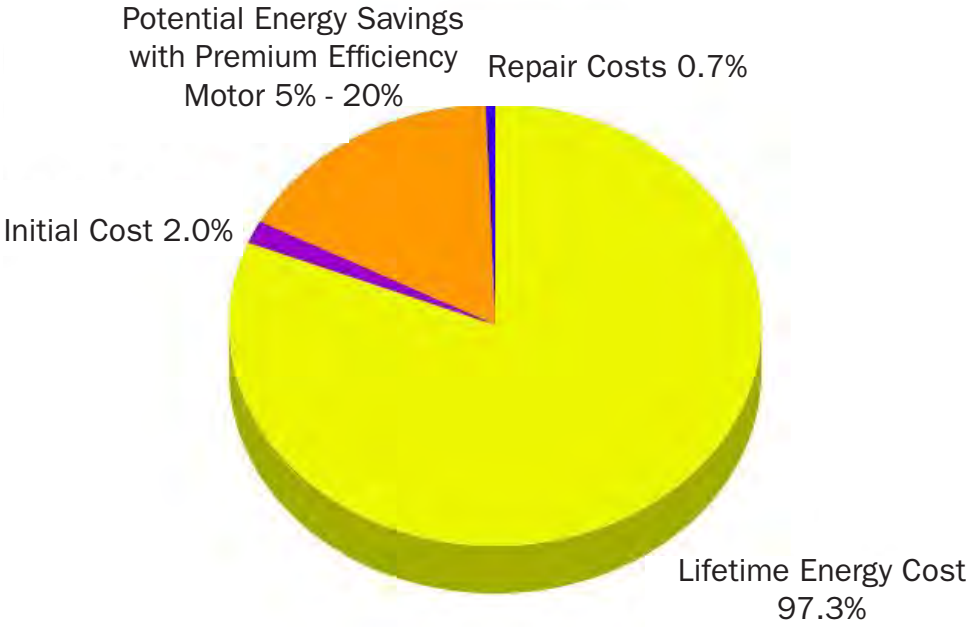

## G18 — ELECTRIC MOTORS: VARIABLE FREQUENCY DRIVE APPLICATIONS

Variable frequency drives (VFDs) match motor output speeds to the specific load and avoid running at constant full power, thereby reducing energy usage. The equipment must be designed so it can operate at peak flows. Peak load designs often do not allow for energy efficient operation at average or low flow conditions. Operators should assess variations in facility flows, including organic loading, and apply VFDs, particularly where peak process demands are significantly higher than average or low demand, and where the motor can run at partial loads.

### See Also

G19 – Electric Motors: Automate to Monitor and Control

### Primary Area/ Process

VFDs apply to most processes in water and wastewater systems where loading conditions fluctuate. They can replace throttling valves on discharge piping, control the pumping rate of a process pump, control conveyance pressure in force mains, control air flow rates from blowers, and control the speed of oxidation ditch drives.

### Productivity Impact

The impact should be minimal with interruption of service only during installation, startup, and fine-tuning.

### Economic Benefit

VFDs are more available and affordable than in previous years, with paybacks usually ranging from six months to five years. The payback period will vary with the application depending on the size of the drive, hours of operation, and variation in load. Large drives, long hours, and high load variability yield the highest savings.

### Energy Savings

Savings vary with application and technology. Many VFD retrofits result in savings of 15 to 35 percent. In some installations, particularly where throttling is used to control flow, savings of 10 to 40 percent are possible. Applied to a wastewater secondary treatment process, a VFD can save more than 50 percent of that process's energy use.

### Applications & Limitations

Applications for VFDs include controlling pressure, daily demand (gpm), fire flow, and well recovery and replenishment. Other applications include controlling aeration blowers, the pumping rate of raw sewage, and sludge processing.

### Practical Notes

Energy saving calculations that account for load variation can demonstrate the benefit and help justify the cost. The system should be assessed by an expert before selecting and installing the VFD to ensure system compatibility and cost-effectiveness. VFDs allow operators to fine-tune their collection, conveyance, and treatment processes.

## Other Benefits

Associated benefits include better control of system flow rate and pressure, more consistent supply, and increased flexibility to meet demand requirements with minimum energy use. Matching drives to loads puts less stress on equipment and may reduce maintenance. Better control of process flows can also reduce chemical usage. In addition, reduced emissions from the power source can be directly related to the reduced consumption of electrical power.

## Stages of Acceptance

VFDs are widely accepted and proven effective in the water and wastewater industry. New and upgraded water and wastewater systems are commonly equipped with VFDs for most system applications.

## G19 — ELECTRIC MOTORS: AUTOMATE TO MONITOR AND CONTROL

The facility should monitor specific process control values, such as dissolved oxygen, pressure, and flow rate; use automatic controls on motors, where feasible; and record system functions in order to optimize motor energy usage while responding to varying loads.

### See Also

G11 – Supervisory Control and Data Acquisition  
G17 – Electric Motors: Install High-Efficiency Motors  
G18 – Electric Motors: Variable Frequency Drives Applications

### Primary Area/ Process

Automatic controls apply to many aspects of water and wastewater systems.

### Productivity Impact

The facility should expect minimum impact, except for a temporary disruption during the installation of the control system. This minor disruption is mitigated by high future returns in operational control and system performance.

### Economic Benefit

Payback varies significantly, depending on the complexity of the controls required, and the variability of the flows and loadings.

### Energy Savings

Typically, energy savings result from the ability to match equipment performance to the real time demands of the treatment, distribution, or collection system. For example, a facility can integrate variable frequency drives with dissolved oxygen (DO) probes to reduce energy consumption.

### Applications & Limitations

Control technologies vary in complexity from simple applications, such as timing clocks that prevent large equipment from operating during peak hours, to more involved systems that control equipment operation based on a number of variables. Examples of more complex systems include filter backwash monitoring and automatic monitors that inform the control of blower speed according to dissolved oxygen levels.

### Practical Notes

Care must be taken in the design and installation of any automatic control system to ensure it is fully integrated and can meet operational requirements, especially in emergency situations. Make sure that system components needed for emergency situations are available. Look for vendors with process and control experience to optimize the entire system.

### Other Benefits

The use of automatic monitoring and control systems to operate a facility may lead to a deeper understanding of facility operations.

### Stages of Acceptance

Acceptance of automatic monitoring and controls in the water and wastewater industry is increasing with simple applications being viewed as “safer” and more complex applications slowly gaining acceptance.

## G20 — ELECTRIC MOTORS: IMPROVE POWER FACTOR

Improve the power factor of electric motors by minimizing the operation of idling or lightly-loaded motors in order to avoid operation above their rated voltage. This can be done by replacing inefficient motors with energy efficient motors that operate near their rated capacity and by installing power factor correction capacitors.

See Also

Not applicable

Primary Area/  
Process

This practice should be applied to all electric motors.

Productivity  
Impact

Minimal impact during installation if motors are replaced

Economic  
Benefit

Electric utility bill savings will occur due to a lower utility service charge, but not from reduced energy costs.

Energy Savings

See above

Applications &  
Limitations

The installation of either single or multiple banks of power factor capacitors is especially beneficial in facilities with larger motors. Many electric utility companies charge the facility if the power factor is less than 0.95.

Practical Notes

Periodic monitoring of power efficiency and load factors can provide valuable information regarding inefficient motor operation or potential motor failure. A motor's efficiency tends to decrease significantly when operated below 50 percent of its rated load, and the power factor also tends to drop off at partial load. Replace motors that are significantly oversized with more efficient, properly-sized motors.

Other Benefits

Motors and drives require proper, routine maintenance to ensure they are operating at optimum performance. Systematic monitoring of power efficiency and load factors can provide valuable information, including an awareness of inefficient motor operation or potential motor failure.

Stages of  
Acceptance

This is standard practice, and utilities seek to have their customers improve the power factor on their systems.

## G21 — PUMPS: OPTIMIZE PUMP SYSTEM EFFICIENCY

The utility should determine the optimum operational conditions for each pump and perform a system analysis. This analysis should include the start-up flows (present low flows) and evolution toward the design flow capacity. Design flow is the system capacity based on a 20-year forecast of flow. An estimated peaking factor indicates the range of flow(s) and head conditions required to meet the conditions and specifications of the system design.

The utility should select the pump or combination of pumps that provide a peak efficiency operating point relative to the common operation condition of the pump. Consider operating a single pump, multiple pumps, multiple pumps of different capacities, and the use of VFDs. The utility can confirm the equipment system selection by calculating the wire-to-water efficiency of each equipment system option under consideration.

### See Also

G18 – Electric Motors: Variable Frequency Drives Applications  
 G22 – Pumps: Reduce Pumping Flow  
 G23 – Pumps: Reduce Pumping Head

### Primary Area/ Process

This best practice should be applied to all water and/or wastewater pumping applications.

### Productivity Impact

Optimizing pumping systems can reduce unscheduled downtime, reduce seal replacement costs, and improve process treatment efficiency and effectiveness.

### Economic Benefit

The payback period depends on site specifics and whether this practice is applied to a new design or retrofit. With a new facility, the payback period should be less than two years; in retrofit conditions, payback typically ranges from three months up to three years.

### Energy Savings

The energy saved will vary with the installation; 15 to 30 percent is typical, with up to 70 percent possible in retrofit situations where a service area has not grown as forecast, or projected operating conditions have not been met.

### Applications & Limitations

No limitations

### Practical Notes

Many computer models can help with the analysis. The model should address both static and dynamic conditions and present and future pumping conditions.

### Other Benefits

Generally, improved pumping systems provide better treatment system control.

### Stages of Acceptance

The technologies used to analyze pumping systems are readily available, and their use is widely accepted.



## Resources

The Department of Energy (DOE) has developed a tool — the Pump System Assessment Tool (PSAT) —that can be used together with the Hydraulic Institute’s Achievable Efficiency Estimate Curves to determine the achievable and optimum efficiencies for the selected pump type, as well as correction factors for specific operating conditions. This method can be used to calculate the energy savings based on the difference between the anticipated energy use of a high-efficiency pump and the baseline energy use associated with inefficient or oversized proposed or existing pumps.

**Find the Pump System Assessment Tool at the following link:**

<http://www.energy.gov/eere/amo/articles/pumping-system-assessment-tool>.

**For additional information on pumping efficiency and wire-to-water insight visit:**

<http://estore.pumps.org/Standards/Centrifugal/SubmersibleTestPDF.aspx> (ANSI/HI 11.6-2012 - American National Standard for Hydraulic Performance, Hydrostatic pressure, mechanical and electrical acceptance tests of Rotodynamic Submersible Pumps).

<http://estore.pumps.org/Standards/Rotodynamic/TestsPDF.aspx> (ANSI/HI 14/6 -2011 - American National Standard for Hydraulic Performance Acceptance Tests of Rotodynamic Pumps) - Appendix G of this document is dedicated to wire-to-water testing.

<http://estore.pumps.org/Standards/Rotodynamic/EfficiencyTestsPDF.aspx> (HI 40.6-2014 - Hydraulic Institute Standard for Methods for Rotodynamic Pump Efficiency Testing) - This standard was developed for the forthcoming DOE Pump Energy Conservation Standard and is a normative reference for determining wire-to-water efficiency of a unit under test.

**Additional Resources:**

<http://estore.pumps.org/Guidebooks/OPS.aspx> (Optimizing Pumping Systems: A Guide to Improved Efficiency, Reliability and Profitability).

<http://estore.pumps.org/Guidebooks/WW.aspx> (Pump Application Guideline: Wastewater Treatment Plant Pumps).

## G22 — PUMPS: REDUCE PUMPING FLOW

Facility operators should actively manage and reduce, where possible, pumping flow rates. Because the energy use of a pump is directly proportional to the pump flow rate, operators should compare the facility's design flow rate with current flow rate and evaluate whether or not system conditions have changed in a way that makes it feasible to reduce pumping rates.

In some applications (e.g., pumping to a storage tank), it is possible to pump at a lower flow rate over a longer period of time, allowing the pump to operate at a point on the pump curve that is optimal for energy efficiency.

Water conservation measures, such as the reduction of infiltration and inflow or leak detection and repairs to the water distribution system, can also reduce the required flow rate.

### See Also

G21 – Pumps: Optimize Pump System Efficiency  
 W5 – System Leak Detection and Repair  
 W7 – Optimize Storage Capacity  
 W8 – Promote Water Conservation

### Primary Area/ Process

This energy-saving practice can be applied to all pumping systems.

### Productivity Impact

No impact

### Economic Benefit

The estimated payback will vary with improvements and comparison against a base alternative. While load shifting and demand flattening (pumping at a lower rate over a longer period of time) do not necessarily result in reduced energy use, they do result in reduced electricity bills (peak demand savings).

### Energy Savings

The potential savings will vary with the type of modifications being considered.

### Applications & Limitations

This applies to all pumping systems.

### Practical Notes

A detailed evaluation should be completed to identify the potential energy savings for each installation.

### Other Benefits

None

### Stages of Acceptance

While the concept is understood, implementing this practice often requires measurement and analysis that is not immediately practicable for some utilities.

## G23 — PUMPS: REDUCE PUMPING HEAD

Operators should aim to reduce the total system head losses, which include static head and friction head losses (due to velocity, bends, fittings, valves, pipe length, diameter and roughness). Energy use in a pump system is directly proportional to the head, and the facility can take the following steps to analyze and improve pump efficiency:

- Plot the system curve at the time of installation
- Compare output on the certified curve for that pump model and size
- Calculate the system efficiency and save for future reference
- Plot the system curve on a yearly basis; examine and re-plot at shorter time periods if problems develop
- Avoid throttling valves to control the flow rate
- Run higher wet well level on the suction side (if practical)
- Increase pipeline size and/or decrease pipe roughness
- Modify header configuration to minimize fittings

### See Also

G21 – Pumps: Optimize Pump System Efficiency  
G24 – Pumps: Avoid Pump Discharge Throttling

### Primary Area/ Process

This practice should be applied to all pump systems.

### Productivity Impact

No impact

### Economic Benefit

The estimated payback will vary with the extent of the improvements and the comparison against a base alternative.

### Energy Savings

The potential savings will vary with the type of modifications being considered.

### Applications & Limitations

This best practice is applicable to all pumping systems. Note that reducing the head too much may result in the pump running to the far right of the best efficiency point (BEP) on the pump curve, which could result in inefficient operation and/or cavitation.

### Practical Notes

A detailed evaluation should be completed to identify the potential energy savings for each installation.

### Other Benefits

Additional benefits of this practice include reduced pump wear, longer service life, and less required maintenance.

### Stages of Acceptance

Reducing the head on pumping systems is widely accepted in the water and wastewater industry.

## G24 — PUMPS: AVOID PUMP DISCHARGE THROTTLING

The facility should modify the operation of a pumping system to eliminate the use of discharge valve throttling to control the flow rate from pumps. As an alternative, the facility may consider energy efficient variable speed drive technologies, such as variable frequency drives (VFDs), or the utilization of a low-capacity pump.

### See Also

G18 – Electric Motors: Variable Frequency Drive Applications

### Primary Area/ Process

This technology is most often applied to well and booster pump discharges. However, it also is used in wastewater pump stations.

### Productivity Impact

No impact

### Economic Benefit

Payback varies by application and may be less than one year if the pump run-time is high and valve closure is significant. However, the measure savings can be as low as 15 percent of total energy consumption if the pump has low hours of operation and the throttling valve is minimally closed.

### Energy Savings

Energy savings can exceed 50 percent of pumping energy in some cases. Actual energy savings depend on the amount of closure of the throttling valve.

### Applications & Limitations

Applied to all locations currently using valves to control flows.

### Practical Notes

A detailed evaluation should be completed to identify the potential energy savings for each installation, giving some consideration to the use of a variable frequency drive and/or smaller-sized pumps.

### Other Benefits

Additional benefits of VFDs are reduced pump wear, longer service life, less required maintenance, and the ability to quickly and easily adjust flow as changes occur in the distribution system or in the ability of a well to recharge.

### Stages of Acceptance

The water/wastewater industry accepts the use of VFDs to replace throttling valves in order to reduce energy consumption and provide improved control of the pump.

## G25 — ULTRAVIOLET (UV) DISINFECTION OPTIONS

The facility should consider various ultraviolet (UV) disinfection system design or redesign options that can reduce the number of lights (bulbs), change bulb orientation, change bulb type (pressure and intensity), adjust the turn-down ratio (bank size and bulb output variability), and apply dose-pacing control (in which system output is automatically controlled to achieve disinfection requirement).

### See Also

Not applicable

### Primary Area/ Process

UV disinfection options can apply to both water and wastewater systems.

### Productivity Impact

There may be a minor impact on productivity during the installation of any improvements.

### Economic Benefit

Payback will vary depending on the following: current type of UV system in use, range of energy-efficiency renovations available, peak design and average flow to be treated, disinfection limit and upstream treatment processes, and current and future energy costs.

### Energy Savings

Energy savings from UV result when the number of lamps “on” and lamp output are paced on the basis of flow rate and transmittance. Current technology, low-pressure, high-output UV lamps use, on average, about half of the energy of medium-pressure lamps. Typical energy requirements for low-pressure, high-output systems range from 2.0 to 4.0 kWh/MGD, while medium-pressure systems use from 5.0 to 8.0 kWh/mgd. Systems that employ effective sleeve cleaning alone can save up to 15 percent of UV system energy consumption.

### Applications & Limitations

Yearly energy savings may be lower for systems that operate seasonally, due to limited annual hours of operation.

### Practical Notes

Medium-pressure lamps convert a lower percentage of the power they consume into useful UV light (roughly 13 percent versus 35 percent), compared with low-pressure/ high-output lamps (LPHO). In addition, medium-pressure lamps previously provided a much lower turn-down capability as compared to present low-pressure/high-output lamps. Consequently, an existing medium-pressure system may use significantly more energy than a new LPHO retrofit. Including an automatic cleaning (wiping) system ensures that the quartz sleeves stay clean and that the maximum amount of UV can be transferred, which improves energy efficiency. In recent years, higher-output LPHO lamps have been developed that have the same turn-down ratio as medium-pressure lamps (up to 1 kW in input power). These newer, higher-power lamps can now replace a medium-pressure lamp system on a one-to-one lamp-count basis.

## Other Benefits

Installation of an ultraviolet (UV) system usually replaces a chlorination system, thereby eliminating on-site storage of chlorine, which can be either a hazardous gas or corrosive liquid. Additionally, using UV disinfection reduces the potential for trihalomethane (THM) formation in the distribution system resulting from disinfection byproduct (DBP) precursors in the water.

## Stages of Acceptance

Many varieties and configurations of UV disinfection systems are accepted and in use throughout the water and wastewater industry.

## G26 — INCORPORATE ENERGY EFFICIENCY IN MEMBRANE TREATMENT SYSTEMS

Membrane bioreactor technology (MBR) is becoming a more popularly utilized water or wastewater treatment option when stringent water quality standards must be achieved. Facilities that utilize MBR technology should be sure to consider energy efficiency in their system selection and design.

MBR is a physical treatment option consisting of microfiltration (MF), ultra-filtration (UF), nano-filtration (NF), reverse osmosis (RO), or a combination of two or more of these systems, depending upon the water quality standards that need to be met. MBR technology can provide specific advantages, such as reduced building size requirements, improved staging implementation, and the flexibility to custom design MBR to meet treatment requirements. However, MBR can present challenges in incorporating energy efficiency in planning and design.

To ensure an energy efficient treatment system, the utility should select the best flux rate membrane for their application. The MBR design should be kept as simple as possible, incorporate reduced air scour during backwashing, and include adequate turn down capability (be sized to meet current flows and design flows in an energy efficient way).

### See Also

G4 – Include Energy Efficiency in Capital Improvement and Operations Plans

### Primary Area/ Process

This practice affects any water or wastewater treatment facility that utilizes or is considering MBR technology, particularly those with stringent quality requirements.

### Productivity Impact

Installation of MBR can be done without interrupting the operation of the system, and including energy efficiency in the MBR design should not affect the level of impact.

### Economic Benefit

Payback will vary depending upon the specific MBR design and its application as a retrofit or a new system.

### Energy Savings

Energy savings will depend on the efficiency of the treatment system being retrofitted or the alternative new baseline treatment system with which it is being compared.

### Applications & Limitations

The MBR treatment option is particularly advantageous for treatment facilities with limiting site conditions, poor water quality, and stringent treatment requirements. For those facilities that choose to utilize MBR, it is important to include energy efficiency considerations in the system selection and design process.

### Practical Notes

For utilities which the technology is a viable option and can include energy efficiency considerations in the design, MBR is an acceptable choice because its capital cost is becoming more competitive compared with other options that can meet stringent water quality requirements.

## Other Benefits

For utilities where MBR is an energy efficient and facility-appropriate treatment option, utilizing the technology can also provide other benefits: MBR systems have smaller space requirements, can be automatically operated, are highly reliable, are more adaptable to phased implementation, and can include a variety of membrane options to meet specific site requirements.

## Stages of Acceptance

Membrane technology is an acceptable treatment option that can include energy efficiency considerations in the system design, and is gaining acceptance as treatment requirements become more stringent.



## G27 — ENERGY EDUCATION FOR FACILITY PERSONNEL

All water and wastewater system personnel should understand the relationship between energy usage and facility operations. Information can be found in various publications, including this handbook, and through training sessions offered by organizations (such as Focus on Energy).

See Also	Not applicable
Primary Area/ Process	This practice focuses on personnel, especially those who make both long- and short-term decisions that affect energy use (including elected officials). All parties involved in the operation of a water treatment and distribution system and a wastewater conveyance and treatment facility can benefit from understanding the system's energy consumption.
Productivity Impact	No impact
Economic Benefit	There is no direct return on investment for this practice. The return is a function of actual process changes and/or operational changes made in response to recommendations from the educational material and/or classes.
Energy Savings	The energy savings for this practice will vary substantially depending on what measures are implemented.
Applications & Limitations	No limitations
Practical Notes	It is useful to establish an annual schedule for energy training to keep facility management and personnel up-to-date on available technology and management practices.
Other Benefits	Staff members and colleagues within the industry typically share and discuss the information they gain from attending education classes and reading publications.
Stages of Acceptance	Education and training is common and widely accepted throughout the industry.

## G28 — ENSURE PLANT PERSONNEL RECEIVE AND UNDERSTAND MONTHLY ENERGY BILLS

All water and wastewater system superintendents/operators should receive and review their system’s monthly energy bills. Energy bills are often sent directly to the business office of the utility where they are opened, reviewed, and paid. The majority of superintendents and operators never see these energy bills and miss the opportunity to gain valuable insight into operations and budgets.

Billing information, critical to understanding the impact of energy costs, includes peak and off-peak consumption (kWh) and peak demand (kW), time of peak, unit costs for peak and off-peak use, and the monthly demand charge component. The energy provider shows 15 or 30 minute demand values. This information can show how the system is operating and indicate potential anomalies, such as excessive, unexplainable consumption. Comparing energy and demand usage data from energy utility bills with data on influent flow and organic strength can broaden the operator’s understanding of the operation. Where practical, plant process efficiency should be part of a manager’s overall performance evaluation.

### See Also

Appendix A: Understanding the Electric Bill

### Primary Area/ Process

This practice should be applied to all water and wastewater systems. Monthly reviews and assessments should be completed and trend graphs continually updated.

### Productivity Impact

No impact

### Economic Benefit

Economic benefit will vary depending on the aggressiveness of the program, the extent of potential operational changes, and the availability of capital investment funding when needed.

### Energy Savings

Energy savings will vary depending on the actions taken as a result of reviewing energy bill information. An action can be as simple as changing the timing of a unit process’s operation (shifting demand to off-peak), or as involved as replacing constant speed motors with variable frequency drives.

### Applications & Limitations

No limitations

### Practical Notes

This best practice has no limitations. Managers of all sizes of water and wastewater systems should understand when and how their systems consume energy.

### Other Benefits

A better understanding of energy bills often results in more attention to the sequence of operations. Water and wastewater treatment schedules can be optimized according to the time of operation.

### Stages of Acceptance

Increasingly, water and wastewater utilities understand the value of the information they receive from their energy provider.



# **BEST PRACTICES**

# **WATER TREATMENT**

THIS PAGE INTENTIONALLY LEFT BLANK



# WATER TREATMENT BEST PRACTICES

## OPERATIONS/SCHEDULING

- W1** Integrate System Demand and Power Demand in System Designs Page 81
- W2** Computer-Assisted Design and Operation Page 82
- W3** Manage Well Production and Drawdown Page 83
- W4** Sequence Well Operation Page 84

## MEASURES

- W5** System Leak Detection and Repair Page 85
- W6** Optimize Storage Capacity Page 86

## WATER DEMAND MANAGEMENT

- W7** Promote Water Conservation Page 87
- W8** Landscape Irrigation Reduction Program Page 89
- W9** Manage High-Volume Users Page 90

\* Ultraviolet (UV) Best Practice presented in G25 on Page 69

THIS PAGE INTENTIONALLY LEFT BLANK

# Water Treatment Best Practices



The following table shows the typical energy savings and payback periods for the Best Practices found in this section, grouped by category, and includes three blank columns for you to complete as you analyze each practice. You can utilize this checklist to track the process of reviewing these Best Practices and note which ones are feasible for your utility and which ones need further review.

Best Practices	Typical Energy Savings of Unit of Process (%)	Typical Payback Years	Best Practice Feasible? (Yes/No)	Date Analyzed	Further Review Needed? (Yes/No)
<b>Operations/Scheduling</b>					
W1 - Integrate System Demand and Power Demand in System Demand	Variable	Variable			
W2 - Computer Assisted Design and Operation	Variable	Variable			
W3 - Manage Well Production and Drawdown	Variable	Variable			
W4 - Sequence Well Operation	Variable	Variable			
<b>Measures</b>					
W5 - System Leak Detection and Repair	Variable	Variable			
W6 - Optimize Storage Capacity	Variable	Variable			
<b>Water Demand Management</b>					
W7 - Promote Water Conservation	Variable	Variable			
W8 - Landscape Irrigation Reduction Program	Variable	Variable			
W9 - Manage High-Volume Users	Variable	Variable			

THIS PAGE INTENTIONALLY LEFT BLANK



## W1 — INTEGRATE SYSTEM DEMAND AND POWER DEMAND IN SYSTEM DESIGNS

Facility management staff should evaluate current system water demand (water consumption) and electric power demand (peak and off-peak). The analysis should address residential, commercial, institutional and industrial usage, plus required fire flow. Water and wastewater utility staff should direct system designers to incorporate energy efficiency best practices in all designs (new and retrofit) to reduce electric peak demand and energy consumption. For well pumps and booster pump stations, the utility should consider the feasibility of applying variable speed drives (VFD) and electric power monitoring, as well as demand controls, to minimize peak demand charges. In addition, when selecting booster station pumps, the utility should compare the flow rate differential between average flow and peak flows (usually fire flow) and assess if the selected pumps can meet both conditions in an energy efficient way.

### See Also

Not applicable

### Primary Area/ Process

This best practice includes all electrical components of water supply, treatment and distribution systems.

### Productivity Impact

Water production and distribution can be expected to improve upon installation of either a new system or retrofit.

### Economic Benefit

The estimated payback period, which is not tied to the evaluation itself, will vary with the extent of proposed improvements and comparison with a base alternative.

### Energy Savings

The purpose of the evaluation is to identify potential savings. The potential savings will vary with the types of modifications implemented.

### Applications & Limitations

The evaluation should advise the comprehensive planning process prior to the development of any improvement project.

### Practical Notes

Careful evaluation and planning can lower capital costs by ensuring that system improvements are appropriate and that new/retrofit equipment is compatible with existing system components.

### Other Benefits

Other benefits of this evaluation include improved production scheduling and the potential for greater environmental compliance. In addition, lower utility costs may result in lower customer bills and more satisfied customers.

### Stages of Acceptance

Careful planning of system improvements has been a hallmark of the water industry. This practice builds on that concept by incorporating the goal of energy efficiency and peak demand management.

## W2 — COMPUTER-ASSISTED DESIGN AND OPERATION

The utility should develop a computer model of the water distribution system to evaluate the impacts of proposed improvements. A system-specific computer model can evaluate potential impacts on the distribution system from changes in pipe size, pumping rates, pump operating point, system pressure, location of booster pumps, location of storage, and variable flow rates. Using this information to adjust system pressures, pumping rates, pump operating points and operational sequence can improve energy management before making capital investments.

### See Also

Not applicable

### Primary Area/ Process

This practice applies to all water distribution systems.

### Productivity Impact

This best practice has no impact on operation or production. Field testing is necessary to calibrate the model to reflect actual field operating conditions.

### Economic Benefit

Payback will be directly related to the identified opportunities for energy savings. Payback benefits begin when the computer model is used to inform and select energy-efficient measures.

### Energy Savings

The potential energy savings will vary with the types of modifications being considered.

### Applications & Limitations

This measure can benefit systems of all sizes. The utility must ensure that, during the implementation of any changes or adjustments, system pressure is maintained at a sufficient level to meet customer demand, fire flow, and code requirements.

### Practical Notes

Many computer modeling programs and tools are available that address both static and dynamic conditions. When selecting software, the utility should look for user-friendliness and expandability that allows the model to change and grow with the system. Conduct computer model analyses on planned system modifications to determine which modifications are energy efficient and can benefit the water system.

### Other Benefits

Computer modeling can help document and justify infrastructure and operational decisions to management. It also provides data for annual reports and information needed for asset management.

### Stages of Acceptance

Use of modeling technology for operations optimization is well received and widely accepted by the industry.

## W3 — MANAGE WELL PRODUCTION AND DRAWDOWN

The water and wastewater utility should monitor, review, and track the physical characteristics and operations of each well, including pumping rates, recharge capabilities, drawdown and recharge areas, and develop a performance chart or trend graphs that display the historic and current conditions.

The utility can use this information to optimize the operation and planning of pumps, motors, and control systems. Particularly, the utility should monitor well drawdown during pump operation to detect any production changes over time. Diminishing recharge may expose the potential for pump failure or other mechanical problems and may indicate increased energy consumption. The water level may also drop to a point where pumping is inefficient.

### See Also

W4 – Sequence Well Operation

### Primary Area/ Process

This practice affects all water systems with wells.

### Productivity Impact

The impact of this best practice is felt during installation, only if new equipment is necessary. Pump failure or excessive drawdown would eventually lead to impact on water production.

### Economic Benefit

A short payback is possible if equipment is in place and only requires adjustment. If new equipment, such as VFDs, is required, the payback period will increase.

### Energy Savings

Energy savings vary widely with the characteristics of each specific component (well, motor, drive, controls) at a site.

### Applications & Limitations

Metered data helps identify the “best point” for operation, which may make the system more energy efficient. Some utilities may require the assistance of an external consultant.

### Practical Notes

A strong maintenance program, coupled with monitoring and review, will always provide improved energy management. Maintaining a log of changes and trending results will also support system planning.

### Other Benefits

Many additional benefits may result from this practice, including lower stress on the system, reduced pumping rate, and a reduced electric peak demand charge. An effective well management program also allows for scheduled maintenance rather than emergency maintenance, makes fluctuations in the aquifer more predictable, and reduces surprises and emergencies.

### Stages of Acceptance

This practice is widely accepted in the water industry. However, many utilities do not fully realize the value of monitoring the condition of wells and equipment, and how it supports planned, preventative maintenance and minimizes emergency maintenance.

## W4 — SEQUENCE WELL OPERATION

Staff should compile and review all water production information available on each well at the site, including energy consumption. Staff should become familiar with the functional characteristics and production capability of each well, noting that many wells are brought on-line with equipment sized to achieve full-capacity production, which may not be necessary. From these data, the utility should identify and implement the proper sequence of well operations, beginning with the most energy-efficient well and ending with the least.

See Also

W3 – Manage Well Production and Drawdown

Primary Area/  
Process

This practice affects water supply and distribution systems that are served by wells.

Productivity  
Impact

Little or no impact on productivity.

Economic  
Benefit

Payback is typically short, because the practice of sequencing well operation usually requires only a low-cost adjustment in procedures, rather than a capital investment, unless an automatic control system is required.

Energy Savings

Savings vary from system to system depending on the condition of existing equipment and current operations.

Applications &  
Limitations

One limitation to this practice is the possibility that water quality and/or distribution issues may require the use of a less energy efficient well over a more efficient one.

Practical Notes

This practice is easy to implement because the data required to perform the analysis are already required for the annual Public Service Commission report.

Other Benefits

Utility personnel can more accurately manage energy efficient well production.

Stages of  
Acceptance

Although this practice is accepted by the industry, not many utilities have adopted it. Generally, this is because its overall value is not fully understood by the utilities.



## W5 — SYSTEM LEAK DETECTION AND REPAIR

The utility should review their system’s annual Public Service Commission water reports to determine the amount of unaccounted water. If the amount exceeds “typical” losses for similar facilities, the utility should use leak detection technology to identify the location of water loss and repair identified leaks. In addition to reducing water loss, repairing leaks can reduce pumping energy requirements.

Operations and maintenance (O&M) practices, such as pipe or meter inspection and maintenance programs, are critical. New technology, such as automatic meter reading (AMR) technology and Computerized Maintenance Management Software (CMMS), can also be useful in identifying water loss.

### See Also

G22 – Pumps: Reduce Pumping Flow

### Primary Area/ Process

This practice is applicable throughout all water distribution systems.

### Productivity Impact

There may be minor disruptions during repair, and disinfection of the section being repaired, before the section is placed back into service.

### Economic Benefit

Payback varies depending on the size and complexity of the distribution system and the extent of any required repairs. Payback periods tend to be longer than those for other energy efficiency projects, since the energy savings may be small when compared to the cost of repairing the leak. The economic evaluation should include the value of the unaccounted water.

### Energy Savings

Potential energy savings will vary with the number and severity of leaks, as well as system pressure.

### Applications & Limitations

This practice is applicable to all distribution systems.

### Practical Notes

The amount of energy saved is small, relative to the cost of repairing leaks in water mains, because excavation in paved areas is expensive.

### Other Benefits

The Public Service Commission may require water loss testing in the future. Integrating leak testing with energy efficiency is a strategic way to leverage resources.

### Stages of Acceptance

Leak detection and repair is standard practice in the industry, but has traditionally been viewed as routine maintenance rather than as an energy efficiency practice.

## W6 — OPTIMIZE STORAGE CAPACITY

The utility should develop a storage capacity utilization strategy to minimize pumping during peak demand periods for electric power. The utility should also develop a strategy for pump operation and water distribution to flatten electric demand during the peak periods and shift as much pumping as possible to off-peak periods. This strategy should include the following tactics:

- Track detailed water demand information by adding metering capabilities to water distribution and transmission lines
- Add or strategically use existing storage capacity to minimize pumping costs during electric peak demand periods
- Use pressure-sustaining or pressure-reducing valves to assist in maintaining minimum pressure requirements in different regions of the water distribution system

See Also

G22 – Pumps: Reduce Pumping Flow

Primary Area/  
Process

This practice applies to all water distribution systems.

Productivity  
Impact

No impact

Economic  
Benefit

Payback will depend on the extent of capital improvements, such as the addition of storage capacity. If only operational modifications are implemented, there may be no capital cost.

Energy Savings

Any utility bill savings will result from reduced electric demand charges and will not come from a reduction in energy usage.

Applications &  
Limitations

The capital cost of any additional storage capacity, new valves and addition metering will have to be balanced with expected savings from reduced electric demand charges. Minimum system pressure during peak flow periods and for fire flow protection must be maintained. Regulatory compliance cannot be undermined and should always be the primary goal.

Practical Notes

None

Other Benefits

Not applicable

Stages of  
Acceptance

This practice is widely accepted by the industry.

## W7 — PROMOTE WATER CONSERVATION

Reducing water consumption on the customer side reduces the energy needed to treat and distribute water. Conservation can also assist with managing diurnal and seasonal peak demand periods. Utilities can promote this by:

- Assessing water-conserving plumbing fixtures and appliances and promote them within the community
- Considering using a multi-tiered residential rate structure that charges a higher rate for high consumption (also known as an “inclined block” or “inverted” rate structure)
- Targeting all customer classes – residential, commercial, institutional and industrial
- Offering water consumption audits for commercial and industrial customers
- Offering financial incentives for commercial and industrial customers to use more water-efficient systems for high water-use applications

### See Also

G22 – Pumps: Reduce Pumping Flow  
W8 – Landscape Irrigation Reduction Program

### Primary Area/ Process

This best practice targets all water utility customers, especially those in the field of new construction and renovations requiring permits.

### Productivity Impact

No impact

### Economic Benefit

Payback depends on campaign effectiveness, customer behavior changes in water use, and the number of customer measures implemented.

### Energy Savings

Savings will depend on the number and types of equipment and appliances that are replaced, as well as changes in consumer behaviors.

### Applications & Limitations

This promotion effort should target all customers, and may be effective for those that perform new construction and renovations that require permits. The utility should be aware that a transition from flat rates to metered and/or conservation rate structures can be politically sensitive and will require significant public education and information. Successful water conservation programs can actually reduce revenues for a utility, and the expected rate impact should be factored into fiscal and regulatory planning.

### Practical Notes

The utility should develop a list of manufacturers that make water-conserving equipment and appliances and make it available to all residential, commercial, institutional, and industrial customers that inquire. The utility could also consider providing incentives to encourage water conservation, limiting landscape irrigation to overnight hours, and providing educational classes on water conservation.

## Other Benefits

The primary benefit of this practice is the conservation of water, which is a limited, critical resource. An effective program helps consumers adjust to long-term water conservation without major impact on their lifestyles.

## Stages of Acceptance

Water-conserving fixtures, appliances, and practices are widely accepted in the industry and by consumers.



## W8 — LANDSCAPE IRRIGATION REDUCTION PROGRAM

Automatically monitored and controlled irrigation systems have been shown to have a major impact on water consumption. The utility should establish a customer program that manages landscape irrigation to avoid electric peak time water consumption and minimize the duration of sprinkling. Implementing this technology will reduce water consumption.

### See Also

W7 - Promote Water Conservation

### Primary Area/ Process

This practice affects water consumption and water distribution systems.

### Productivity Impact

This best practice has no impact on operations. It may have a beneficial impact on production by reducing well drawdown during poor well recharge times.

### Economic Benefit

The payback period will be very short, if not immediate, and will begin when customers reduce their water consumption.

### Energy Savings

Potential energy savings, derived from reduced pumping costs, will vary with changes in customers' landscape irrigation habits.

### Applications & Limitations

While there are no physical limits regarding landscape irrigation regulations, gaining customer cooperation and enforcing the regulations may present challenges.

### Practical Notes

The utility must assess year-round use and the potential to affect peak water consumption through rules that regulate time and duration of lawn sprinkling. This effort requires an information campaign backed by enforcement. The water utility can also consider providing guidance for landscaping practice to reduce irrigation requirements (xeriscaping).

### Other Benefits

The primary benefit of this practice is the conservation of water, which is a limited, critical resource. This practice may also reduce well drawdown.

### Stages of Acceptance

The effectiveness of this practice is widely understood and accepted. Still, gaining public acceptance can be a challenge since restricting lawn sprinkling may be viewed as an infringement on personal rights.

## W9 — MANAGE HIGH-VOLUME USERS

The utility should meet with the ten largest water users in its system to identify potential modifications to customer operations that may reduce their water consumption. The utility should encourage them to adopt and monitor the identified measures and to consider recycling water where applicable.

### See Also

Not applicable

### Primary Area/ Process

This practice applies to water supply and distribution systems.

### Productivity Impact

There is no impact on the water utility other than the intended reduction in water consumed. Any disruption during implementation would take place at the customers' facilities.

### Economic Benefit

The payback for the water utility is nominal, since the only cost is for promotion of the program. Customer payback varies with the amount of water conservation and the complexity of the measures needed to achieve the savings.

### Energy Savings

Energy savings are proportional to the reduction in water use.

### Applications & Limitations

Since any reduction in water use results in a corresponding reduction in revenue, each water utility has a limit on how much water can be conserved before it becomes necessary to evaluate their user charges and possibly modify the water utility rates.

### Practical Notes

The utility should aim to minimize water utility rate impacts through fiscal planning and regulatory rate development. The utility should also determine if customers' peak usage of water can be shifted to off-peak times for electric and water savings, such as evening and nighttime hours, to reduce costs for both the customer and water utility.

### Other Benefits

This practice may extend the life of water supply and distribution systems and may also postpone costly future expansions. In industrial applications it may reduce the customers' cost of producing their product.

### Stages of Acceptance

This practice is not widely adopted by utilities, due to the threat of reduction in utility revenue. Typically, customers respond favorably to this concept, as long as the suggested measures do not negatively impact production, product quality, or operations.



# BEST PRACTICES

# WASTEWATER

THIS PAGE INTENTIONALLY LEFT BLANK



# WASTEWATER BEST PRACTICES

## OPERATIONS/SCHEDULING

<b>WW1</b>	Operational Flexibility	Page 97
<b>WW2</b>	Staging of Treatment Capacity	Page 99
<b>WW3</b>	Manage for Seasonal/Tourist Peaks	Page 100
<b>WW4</b>	Flexible Sequencing of Basin Use	Page 101
<b>WW5</b>	Cover Basins to Reduce Freezing and Aerosol or Odor Emissions	Page 102
<b>WW6</b>	Reduce Fresh Water Consumption through Final Effluent Recycling	Page 103

## AERATION

<b>WW7</b>	Optimize Aeration System	Page 104
<b>WW8</b>	Fine-Bubble Aeration	Page 105
<b>WW9</b>	Variable Blower Air Flow Rate	Page 106
<b>WW10</b>	Dissolved Oxygen Control	Page 107
<b>WW11</b>	Post-Aeration: Cascade Aeration	Page 108

## AERATION

WW12	Aerobic Digestion Options	Page 109
WW13	Blower Technology Options	Page 111
WW14	Assess Aeration System Configuration	Page 113

## SLUDGE AND BIOSOLIDS

WW15	Sludge: Improve Solids Capture in Dissolved Air Flotation (DAF) System	Page 114
WW16	Sludge: Evaluate Replacing Centrifuge with Screw Press	Page 115
WW17	Sludge: Consider Replacing Centrifuge with Gravity Belt Thickener	Page 117
WW18	Biosolids Digestion Options	Page 118
WW19	Biosolids Mixing Options in Aerobic Digesters	Page 120
WW20	Biosolids Mixing Options in Anaerobic Digesters	Page 121
WW21	Recover Heat from Wastewater	Page 122

## SPECIAL TREATMENT OPTIONS

WW22	Anoxic Zone Mixing Options	Page 123
WW23	Sidestream Deammonification	Page 124
WW24	Biotower Energy Efficiency	Page 126

## BIOGAS ENHANCEMENT AND UTILIZATION

WW25	Optimize Anaerobic Digester Performance	Page 128
WW26	Use Biogas to Produce Combined Heat and/or Power (CHP)	Page 130
WW27	Biogas: Assessment of Beneficial Utilization	Page 131

\* Ultraviolet (UV) Best Practice presented in G25 on Page 69

# Wastewater Best Practices



The following table shows the typical energy savings and payback periods for the Best Practices found in this section, grouped by category, and includes three blank columns for you to complete as you analyze each practice. You can utilize this checklist to track the process of reviewing these Best Practices and note which ones are feasible for your utility and which ones need further review.

Best Practices	Typical Energy Savings of Unit of Process (%)	Typical Payback Years	Best Practice Feasible? (Yes/No)	Date Analyzed	Further Review Needed? (Yes/No)
<b>Operations/Scheduling</b>					
WW1 - Operational Flexibility	10 - 25	< 2			
WW2 - Staging of Treatment Capacity	10 - 30	< 2			
WW3 - Manage for Seasonal/Tourist Peaks	Variable	4 - 6			
WW4 - Flexible Sequencing of Basin Use	15 - 40	2 - 5			
WW5 - Cover Basins to Reduce Freezing and Aerosol or Odor Emissions	Variable	Variable			
WW6 - Reduce Fresh Water Consumption through Final Effluent Recycling	10 - 50	2 - 3			
<b>Aeration</b>					
WW7 - Optimize Aeration System	30 - 70	3 - 7			
WW8 - Fine-Bubble Aeration	20 - 75	1 - 5			
WW9 - Variable Blower Air Flow Rate	15 - 50	< 3			
WW10 - Dissolved Oxygen Control	20 - 50	2 - 3			
WW11 - Post-Aeration: Cascade Aeration	Variable	Variable			
WW12 - Aerobic Digestion Options	20 - 50	Variable			
WW13 - Blower Technology Options	10 - 25	1 - 7			
WW14 - Assess Aeration System Configuration	Variable	Variable			

Best Practices	Typical Energy Savings of Unit of Process (%)	Typical Payback Years	Best Practice Feasible? (Yes/No)	Date Analyzed	Further Review Needed? (Yes/No)
<b>Sludge and Biosolids</b>					
WW15 - Sludge: Improve Solids Capture in Dissolved Air Flotation (DAF)	Variable	Variable			
WW16 - Sludge: Evaluate Replacing Centrifuge with Screw Press	Variable	Variable			
WW17 - Sludge: Replace Centrifuge with Gravity Belt Thickener	Variable	Variable			
WW18 - Biosolids Digestion Options	Variable	Variable			
WW19 - Biosolids Mixing Options in Aerobic Digesters	10 - 50	1 - 3			
WW20 - Biosolids Mixing Options in Anaerobic Digesters	Variable	Variable			
WW21 - Wastewater Heat Recovery	Variable	Variable			
<b>Special Treatment Options</b>					
WW22 - Anoxic Zone Mixing Options	25 - 50	3 - 5			
WW23 - Sidestream Deammonification					
WW24 - Biotower Energy Efficiency	15 - 30	Variable			
<b>Biogas Enhancement and Utilization</b>					
WW25 - Optimize Anaerobic Digester Performance	Variable	Variable			
WW26 - Use Biogas to Produce Combined Heat and/or Power (CHP)	Variable	Variable			
WW27 - Biogas Assessment of Beneficial Utilization	Variable	Variable			



## WW1 — OPERATIONAL FLEXIBILITY

The utility should evaluate facility loadings and become familiar with each unit treatment process and system in order to identify, plan and design the most energy-efficient and effective ways to operate the system while maintaining operational and regulatory requirements. Options to consider include:

- Operating fewer aeration tanks.
- Installing variable frequency drives so that equipment operation can match system loadings.
- Installing dissolved oxygen monitoring and control equipment.
- Reducing air flow to the aeration tanks during low-load periods (usually nights and weekends).
- Waiting to recycle supernatant during lower-flow periods, avoiding periods of high organic loading and peak electric demand.
- Operating (bumping) diffusers or recycling backwash water during off-peak power demand periods.
- Installing an extra, smaller-capacity pump alongside existing pumps so that the facility is able to meet existing flows, low flows, and design flows.

### See Also

G18 – Electric Motors: Variable Frequency Drive Applications  
WW2 – Staging of Treatment Capacity  
WW3 – Manage for Seasonal/Tourist Peaks  
WW4– Flexible Sequencing of Basin Use  
WW7 – Optimize Aeration System  
WW10 – Dissolved Oxygen Control

### Primary Area/ Process

This practice applies to grit removal, secondary treatment processes, all pumping operations, disinfection systems, and biosolids management systems.

### Productivity Impact

Implementation usually involves modifications to operations, so there should be little or no impact on productivity.

### Economic Benefit

Payback is generally within two years since most of the measures are operational adjustments and will not require significant capital costs.

### Energy Savings

Energy savings will vary depending on the measure. A typical range is from 10 to 25 percent.

### Applications & Limitations

All facilities should apply this practice to reduce energy consumption and operating costs.

### Practical Notes

Having an energy management plan (described in the first section of this handbook) will facilitate this practice. Measures should only be considered when there is flexibility in the facility, and when they will not negatively impact meeting load or regulatory permit requirements.

## Other Benefits

Operations personnel will gain a better understanding of the capabilities of the treatment system they control.

## Stages of Acceptance

Many facility operators accept the need to adjust operations in response to loadings once they learn the value and magnitude of the energy savings available.

## WW2 — STAGING OF TREATMENT CAPACITY

When planning improvements, the utility should establish a team that can determine how modular additions can be staged to meet current and projected treatment and design conditions. Staging construction according to smaller-sized, modular equipment so that new units can be brought on-line as needed can both optimize a system's response to treatment demand and allow the facility to better manage energy usage and costs.

For example, the facility could construct two aeration tanks and divide them in half, utilizing half of one tank at start-up, ramping up to one whole tank, then to one and a half tanks and, finally, to two tanks. The same concept can be applied to aeration blowers. They can be sized to meet incremental conditions all the way up to 20-year design conditions. If selected in small enough sizes, they may be brought on-line or off-line, as air demand changes, to meet all conditions from start-up to design.

See Also

WW1 – Operational Flexibility

Primary Area/  
Process

Staging is most applicable to the most energy-intensive components of a system, typically the secondary treatment process, pumping, disinfection, and biosolids management.

Productivity  
Impact

Unless capital improvements are required, there should be no disruption to productivity. A system will usually operate most efficiently when loaded closer to its design load; therefore, staged systems will generally function efficiently throughout the life of the improvement.

Economic  
Benefit

The payback period will usually be less than two years, because minimal system adjustments are required to implement staging.

Energy Savings

Proper staging of treatment capacity can achieve a savings of 10 to 30 percent of the total energy consumed by a unit process.

Applications &  
Limitations

Staging is applicable to all systems.

Practical Notes

Staging usually has a minor impact on construction and scheduling in exchange for the energy savings realized.

Other Benefits

An additional benefit to staging is improved control of the system.

Stages of  
Acceptance

Staging of treatment capacity is accepted in the wastewater industry. However, it has not been readily adopted due to the incorrect belief that the entire system must be built to 20-year design specifications, rather than added in stages in response to increasing demand.

## WW3 — MANAGE FOR SEASONAL/TOURIST PEAKS

Flexible system design allows a utility to adjust and operate more energy efficiently during peak tourist loads as well as during the “off-season.” In many areas, tourism-related loads can be as much as 10 times larger than off-season loads. These variable conditions may require idling treatment units during the off-season.

### See Also

WW1 – Operational Flexibility  
WW2 – Staging of Treatment Capacity

### Primary Area/ Process

Primary areas of focus are the raw wastewater pumps, followed by the secondary treatment processes, disinfection, and solids management.

### Productivity Impact

No impact, other than brief interruptions while idled equipment is placed into operation as needed.

### Economic Benefit

Most retrofit aeration modifications have paybacks of four to six years. If the concept is integrated into the design of new construction, the payback should be shorter.

### Energy Savings

Savings will vary, but can reach 50 percent during the off-season.

### Applications & Limitations

The utility must account for environmental and/or climatic considerations in order to prevent damage to seasonally out of service equipment.

### Practical Notes

This strategy needs to be carefully analyzed to ensure that adequate treatment can be provided during the tourist season. The aeration tanks must be sized so they can be idled during the off-season. It helps to review several years of facility loading data and utility bills to assess seasonal variation and define the peak and off-peak seasons and their respective peak loadings for proper sizing and selection of equipment. Consideration must be given to the proper procedures for idling a tank, and the equipment within it, and then placing it back into operation.

### Other Benefits

If the secondary treatment process is improved, generally the functions of other processes improve also.

### Stages of Acceptance

These concepts are well-known, understood, and widely accepted.

## WW4 — FLEXIBLE SEQUENCING OF BASIN USE

The selection of basin sizes can have a large impact on the energy consumed at a facility during its lifetime. The design team should review the existing and projected organic loadings to select the correct tank sizes. Typically, the use of smaller basins is beneficial so early lifetime loadings can be processed effectively. The remaining basins can then be loaded sequentially, as loads increase, until design capacity is reached. This approach allows for energy-efficient operation from start-up to design flow conditions.

### See Also

WW1 – Operational Flexibility  
WW2 – Staging of Treatment Capacity

### Primary Area/ Process

This practice applies to secondary treatment processes, particularly at activated sludge treatment facilities.

### Productivity Impact

No impact

### Economic Benefit

Payback for constructing multiple tanks will depend on space availability at the site. Implementation can be as simple as adding an interior wall to subdivide an existing tank. This can provide a two- to three-year payback. Payback may take three to five years for major site modifications.

### Energy Savings

Energy savings of 15 to 40 percent are common if multiple smaller tanks are available to step the system into operation, compared with having only two large tanks.

### Applications & Limitations

All facilities should consider operational flexibility in order to manage the continually varying facility loads.

### Practical Notes

Facility personnel should work closely with designers throughout the design process. Information on the sizes and operation of basins required for a treatment process is invaluable to the selection process. Operating highly-loaded, smaller tanks, instead of larger, under-loaded tanks, is the preferred practice. Using intermediate tank walls (division walls) may be a simple, acceptable solution. Proper procedures should be developed for idling and then reactivating a process so that the treatment facility remains in compliance.

### Other Benefits

This practice improves overall operation of the facility and can reduce other associated treatment costs, by reducing polymer requirements, because solids are not over-aerated and fragmented.

### Stages of Acceptance

Acceptance varies from site to site based on facility staff preferences and experience with taking tanks in and out of service.

## WW5 — COVER BASINS TO REDUCE FREEZING AND AEROSOL OR ODOR EMISSIONS

This practice reduces, or possibly eliminates, the likelihood of water surfaces freezing or emitting aerosols and odors. For tanks located in rooms where frequent air changes are required, the utility should cover basins to reduce the volume of fresh air required for the maintenance of good indoor air quality and dehumidification requirements.

### See Also

Not applicable

### Primary Area/ Process

This practice may be applied to any open-tank treatment process including grit removal, comminution, clarification, aeration, post-aeration, gravity thickeners, aerobic digesters, biosolids holding tanks and disinfection tanks.

### Productivity Impact

Installation of covers would interrupt the use of a tank for a limited time during installation.

### Economic Benefit

Payback depends on the number and size of tanks, and the size of the room where tanks are located. The payback period will increase with the amount of equipment needed to implement this practice.

### Energy Savings

Energy savings are not the primary benefit of this best practice, there may also be incremental savings due to a more controlled environment if aerosol emissions, odors, and/or humidity become issues that need to be addressed.

### Applications & Limitations

This practice may be limited by weather conditions.

### Practical Notes

Many enclosure materials are available for basin covers. Information on these materials can be found on manufacturers' websites.

### Other Benefits

Covering a structure results in improved control of odor and aerosol emissions as well as control of surface freezing and temperature loss, both of which are important parameters for a utility to manage within their treatment process.

### Stages of Acceptance

Covering open tanks is a widely-accepted practice throughout the industry.

## WW6 — REDUCE FRESH WATER CONSUMPTION THROUGH FINAL EFFLUENT RECYCLING

Reducing the consumption of potable water through the recycling and utilization of final effluent (FE) in process applications or wash-down of tanks may save energy by reducing the volume of potable water treated and/or pumped. The FE system should include a pressure tank and pump control system, where appropriate, and should include direct pumping or individual booster pumps where high-pressure water is specifically required (such as a belt press). Additional applications are possible with an in-line filter prior to each application.

### See Also

Not applicable

### Primary Area/ Process

This practice is typically applied in the recycle system for grit washing, tank wash-down, gravity belt thickener, belt press, belt wash water, cooling water for a compressor, etc.

### Productivity Impact

This practice has no impacts on production, other than minor interruptions during the installation of any required equipment.

### Economic Benefit

Payback periods for this best practice are typically two to three years and will vary with the volume of potable water used.

### Energy Savings

Savings may reach 50 percent of the total effluent recycle system energy if the existing system does not use a pressure tank system to regulate supply. Additional energy savings will result from the reduction in potable water used.

### Applications & Limitations

Application of this practice is limited by the quality of effluent available for recycling.

### Practical Notes

This best practice is usually implemented when the final effluent quality is so high that its use will not hamper the function of pumps, hoses, and nozzles used in its distribution. The practice is also cost-effective when large volumes of wash water are required, such as for biosolids processing or facility wash-down.

### Other Benefits

Other potential benefits associated with this measure include the reduction of well water consumption, a reduction in the operation of booster pumps (where applicable), and possible elimination of the need for two water distribution systems throughout the facility.

### Stages of Acceptance

The practice of reducing the volume of potable water used in the wastewater treatment process is widely accepted throughout the industry.

## WW7 — OPTIMIZE AERATION SYSTEM

The utility should assess the aeration system to determine if it is operating as energy-efficiently as possible for the required level of treatment. This assessment should compare the present loading conditions and system performance in kWh per million gallons and other key performance indicators (KPIs) with those of similar facilities. The utility should consider the potential benefits and costs of improvements such as fine-bubble aeration, dissolved oxygen control, and variable air flow rate blowers (see below).

### See Also

WW1 – Operational Flexibility  
 WW8 – Fine-Bubble Aeration  
 WW9 – Variable Blower Air Flow Rate  
 WW10 – Dissolved Oxygen Control  
 WW14 – Assess Aeration System Configuration

### Primary Area/ Process

This practice is primarily implemented in secondary treatment process activated sludge, aerobic digestion, channel aeration, and post-aeration systems.

### Productivity Impact

Modified aeration systems may result in different types of savings for other treatment unit processes. For example, in biosolids processing, this practice may lead to a reduction in the polymer dosage requirements for biosolids thickening and dewatering. This practice has also led to increased treatment capabilities at most facilities. In some locations, final effluent quality has improved.

### Economic Benefit

The payback period is generally three to seven years for retrofits and about one year for new construction.

### Energy Savings

Savings of 30 to 70 percent of total aeration system energy consumption are typical.

### Applications & Limitations

This practice can be applied to all aerated treatment systems.

### Practical Notes

This best practice should be implemented at all facilities with aeration opportunities unless there is an overwhelming reason to avoid it.

### Other Benefits

This practice often results in improvement in other unit treatment processes and reduced maintenance at some facilities.

### Stages of Acceptance

Fine-bubble aeration methods are widely accepted, as are dissolved oxygen monitoring and control systems and various methods of controlling the flow rate of air to the treatment process.



## WW8 — FINE-BUBBLE AERATION

Utilities with activated sludge treatment facilities should assess the feasibility of implementing fine-bubble aeration, which provides energy-efficient treatment of wastewater. Fine-bubble aeration can be installed in new systems or retrofitted into existing systems. The technology usually improves operations and increases the organic treatment capability of a wastewater treatment facility. For optimum performance, the utility should combine this practice with dissolved oxygen monitoring and control and a variable capacity blower, and should monitor blower pressure. A facility that installs fine-bubble aeration should plan for periodic diffuser cleaning (in-place gas cleaning system or scheduled drain and manual cleaning), as diffuser fouling influences system pressure, oxygen transfer efficiency, and energy efficiency. To this end, it is usual practice to periodically “bump” the diffusers to maintain proper pressure drop and maximize oxygen transfer capability.

### See Also

WW7 – Optimize Aeration System  
 WW9 – Variable Blower Air Flow Rate  
 WW10 – Dissolved Oxygen Control

### Primary Area/ Process

The primary application for this best practice will be on aeration tanks, aerobic digesters, channel aeration, and post-aeration.

### Productivity Impact

Minor impact during installation

### Economic Benefit

Economic benefits vary between new facilities and retrofit applications. A new system may pay back in as little as one year, while payback on a retrofit will vary depending on the inefficiency of the existing system and the amount of new equipment required.

### Energy Savings

Energy savings range from 20 to 75 percent of the aeration or aerobic digestion unit’s energy consumption.

### Applications & Limitations

This practice applies to all aeration systems. A limit exists for aerobic digestion – if the system operates at a solids concentration of 2.5 percent or greater, further review should first be done.

### Practical Notes

Fine-bubble technologies have applications for all sizes of wastewater treatment facilities. The percentage range of energy savings will be similar regardless of facility size. Fine-bubble can replace mechanical aerators, but the facility should consider the ability to maintain proper mixing when assessing this modification.

### Other Benefits

Most sites that have implemented this practice report improved biosolids management, reduced polymer usage, better clarification, and better overall effluent quality.

### Stages of Acceptance

This technology has gained a high level of acceptance in the industry.

## WW9 — VARIABLE BLOWER AIR FLOW RATE

The utility should require the aeration system and aerobic digester blowers have variable air supply rate capability, such as multi-stage or single-stage centrifugal blowers with VFD; positive displacement blowers with VFD; inlet guide-controlled single-stage centrifugal blowers; and/or turbo blower with a VFD. The range of variability should respond to the specific requirements a site needs to precisely match system demands. The blower system should be able to supply either the minimum air flow required to meet existing low load conditions, or the minimal air flow rate to meet mixing conditions of the aeration system and to meet the high loads of design conditions. The utility should avoid air flow discharge throttling and unnecessary back-pressure, assess the application properly to ensure the correct delivery pressure, and avoid delivery at a pressure higher than the process requires.

### See Also

WW7 – Optimize Aeration System  
 WW8 – Fine-Bubble Aeration  
 WW10 – Dissolved Oxygen Control  
 G18 – Electric Motors: Variable Frequency Drive Applications

### Primary Area/ Process

This practice applies to all aeration systems, including aerated grit, activated sludge aeration tanks, aerobic digestion systems, channel aeration, and post-aeration systems.

### Productivity Impact

Interruption in production should occur only during installation.

### Economic Benefit

Payback is usually under three years.

### Energy Savings

Energy savings depend on site conditions and which parameter, mixing or organic loading, dictates the lesser amount of air flow required by the system. Savings will range from 15 to 50 percent of the energy consumed by this process.

### Applications & Limitations

This practice can be applied wherever blowers are installed.

### Practical Notes

Variable air flow rate blowers should be integrated with fine-bubble aeration as well as dissolved oxygen monitoring and control for optimum energy efficiency. The utility should consider the potential advantages of staging loads and replacing two blowers with three, four, or five smaller units that can meet both current and future demands.

### Other Benefits

When teamed with fine-bubble diffusers and dissolved oxygen (DO) control technologies, effluent quality and biosolids processing are usually improved.

### Stages of Acceptance

Technologies for varying air flow rates are well-received. Variable speed positive displacement blower arrangements and variable capacity centrifugal blowers are becoming more available, and numerous installations now exist.

## WW10 — DISSOLVED OXYGEN CONTROL

The utility should consider automatic dissolved oxygen (DO) control technology that will monitor and maintain the dissolved oxygen concentration level of the aeration tank(s) and post-aeration systems at a preset control point by varying the air flow rate delivered to the aeration system.

### See Also

WW1 – Operational Flexibility  
 WW7 – Optimize Aeration System  
 WW8 – Fine-Bubble Aeration  
 WW9 – Variable Blower Air Flow Rate

### Primary Area/ Process

The primary applications of this practice are on aeration tanks at activated sludge facilities and aerobic digestion and post-aeration systems.

### Productivity Impact

Installation of most systems can be accomplished without interfering with normal operation.

### Economic Benefit

Paybacks for utilizing dissolved oxygen control technology are usually two to three years.

### Energy Savings

Savings vary depending on the efficiency of the present system. Generally, energy savings for an aeration system range from 20 to 50 percent.

### Applications & Limitations

Limitations will vary with the characteristics of the waste being treated. If the waste has characteristics that can easily foul a DO probe, the DO system will not be readily feasible. Maintenance of the DO probe to preserve its monitoring capability is the key to achieving maximum energy efficiency.

### Practical Notes

This control strategy should be employed at post-aeration systems and wherever activated sludge is used as the secondary treatment process. Variable flow may be provided through the use of variable frequency drives (VFDs). Self-cleaning monitoring probes may reduce maintenance frequency and maintain energy-efficient operation for extended periods of time.

### Other Benefits

A DO-controlled system can improve the dewatering characteristics of waste biosolids, and will have fewer problems treating a fluctuating influent load, compared to systems without DO control technology.

### Stages of Acceptance

DO control is a well-established control methodology. The primary factor affecting acceptance is the concern about the reliability and potential maintenance costs related to DO probes.

## WW11 — POST-AERATION: CASCADE AERATION

The utility should consider the installation of a cascade aeration system for post-aeration applications. If the topography is favorable, this technology provides re-aeration of the effluent by increasing the water turbulence as it flows over the steps, without a need for electricity.

### See Also

Not applicable

### Primary Area/ Process

This practice applies to the post-aeration of a wastewater treatment facility's effluent.

### Productivity Impact

Installation of a cascade aeration system can be accomplished without interfering with normal operation.

### Economic Benefit

The payback for this practice varies depending on the existing post-aeration system used.

### Energy Savings

If cascade aeration is used to replace an existing post-aeration system that had either a subsurface diffuser system and blowers or a surface aeration arrangement, the utility can save 100 percent of the replaced system's electricity consumption.

### Applications & Limitations

The application of this best practice is site-specific. About 10 to 15 feet of head (elevation differential) is needed between the final effluent point of discharge and the elevation of the receiving body of water, due to the low oxygen transfer rate and the temperature dependency of oxygen transfer.

### Practical Notes

This process is only applicable at facilities with the appropriate topographical conditions.

### Other Benefits

None

### Stages of Acceptance

Cascade aeration for effluent re-aeration is a well-established method.

## WW12 — AEROBIC DIGESTION OPTIONS

The utility should assess the operation of its aerobic digester to determine if better control of air flow could be achieved through either using a separate smaller blower and/or using flexible membrane fine-bubble diffusers and equipment with adjustable air flow rates. Many facilities operate aerobic digesters with surface aerators or coarse-bubble diffusers that have limited ability to modify or control the amount of air flow delivered to the process.

First, the facility should consider flexible membrane fine-bubble diffusers, which allow for variable air flow rates in digester applications. Second, the facility should choose equipment and/or controls with adjustable air flow rates. Often, air for the digestion process is bled from the activated sludge blowers within the secondary treatment process, allowing little or no control over the air flow delivered.

### See Also

WW7 – Optimize Aeration System  
 WW8 – Fine-Bubble Aeration  
 WW9 – Variable Blower Air Flow Rate  
 WW10 – Dissolved Oxygen Control  
 WW18 – Biosolids Digestion Options  
 WW19 – Biosolids Mixing Options in Aerobic Digesters

### Primary Area/ Process

This practice applies to biosolids treatment and management.

### Productivity Impact

Conversion to flexible membrane fine-bubble diffuser technology and a smaller blower may improve the process of reducing volatile solids.

### Economic Benefit

Payback for this practice varies with the modifications required.

### Energy Savings

The application of flexible membrane fine-bubble diffusers and a separate smaller blower in an aerobic digestion system can reduce energy consumption for the process by 20 to 50 percent.

### Applications & Limitations

The key limitation to this practice is the final concentration of total suspended solids (TSS) in the aerobic digester. Operators may wish to be directly involved in the control of the concentration of TSS to maintain applicability of flexible membrane fine-bubble diffusers. Mixing can also be a limitation.

### Practical Notes

This best practice is applicable to most systems, but will typically require that the diffusers and blowers be replaced. Some piping modifications may also be required.

## Other Benefits

Application of this practice can yield the following benefits:

- Improved biosolids dewatering.
- Reduced polymer demand when the digested biosolids are thickened or dewatered.
- Less pin floc in the biosolids processing.
- Improved reduction of volatile solids.
- Improved decanting from the digester.
- Reduced volume of biosolids for disposal.

## Stages of Acceptance

This technology is readily available and widely accepted, except in situations where the solids concentration within the aerobic digester exceeds 2.5 percent total suspended solids.

## WW13 — BLOWER TECHNOLOGY OPTIONS

Blower technology is continually evolving, providing more energy-efficient options to select from. This evolution in blowers needs to be continually researched and monitored by the utility to identify the most energy-efficient technology for the application being assessed. Current research and development and improved controls have brought turbo blowers and new technology screw blowers to wastewater treatment facilities. This technology, along with single-stage variable vane blowers, provides options to the designers of wastewater treatment facilities. The value of this evolving technology is that blowers are increasingly energy-efficient and can now operate more efficiently over a wider range of air flow rates. Utilities should research, assess, and utilize the most current energy efficient blower technology available for a specific application to ensure a selection that is energy-efficient from start-up through design and that can be integrated with other elements to make the entire facility energy-efficient.

### See Also

WW7 – Optimize Aeration System  
 WW8 – Fine-Bubble Aeration  
 WW9 – Variable Blower Air Flow Rate  
 WW10 – Dissolved Oxygen Control

### Primary Area/ Process

This best practice applies to all aeration applications, including aerated grit, activated sludge aeration tanks, aerobic digestion tanks, post-aeration tanks, aerated channels, and air-assisted final filter backwash applications.

### Productivity Impact

The only interruption in treatment would occur during installation.

### Economic Benefit

Economic benefits of this practice vary between new facilities and retrofit applications. Payback on a new application may be as short as a year, while payback on a retrofit application will depend on the inefficiency of the existing

### Energy Savings

Energy savings will depend on the specifics of the opportunity but generally range from 15 to 25 percent based on improved blower energy efficiency.

### Applications & Limitations

This best practice should be applied wherever blowers are installed. If applying turbo or centrifugal blowers to variable submergence processes, such as SBRs or aerobic digesters, the control system must be able to maintain operation of the system within safe limits.

### Practical Notes

New technology blowers should be assessed for any existing or new design application. The new blowers are often more energy efficient and have an expanded operating range when compared to former technologies at the same air flow rate and pressure conditions. Because capital expense for new blowers may be high, the utility should also evaluate the cost-effectiveness of adding VFDs to achieve variable capacity with existing blowers.

## Other Benefits

When new blowers are integrated with other energy-efficient modifications, such as fine-bubble diffusers and dissolved oxygen control, effluent quality may be improved, and the facility may gain additional overall treatment capability.

## Stages of Acceptance

Application of new blower technology has gained an increasing level of acceptance.





## WW14 — ASSESS AERATION SYSTEM CONFIGURATION

The utility should review and assess the aeration system to determine if the aeration blowers are supplying air flow to one demand (aeration tanks) or multiple demands (aerated grit chambers, aeration tanks, aerobic digesters, channel aeration, post-aeration, air lift pumps, and mixing distribution structures). If the blowers are providing air to more than a single demand, it is likely that the aeration system is not energy-efficient. The system is operating inefficiently because the blower is providing air flow to demands that have different pressure requirements and periodic demands. The utility should assess the airflow and pressure requirements for each demand separately to identify the level of energy savings available if each demand is individually met by a blower for its specific requirements.

### See Also

WW1 – Operational Flexibility  
 WW8 – Fine-Bubble Aeration  
 WW9 – Variable Blower Air Flow Rate  
 WW10 – Dissolved Oxygen Control

### Primary Area/ Process

This practice primarily applies to secondary treatment process activated sludge, aerobic digestion, channel aeration, structure mixing, and post-aeration systems.

### Productivity Impact

Modified aeration systems can result in improved automatic process control. This occurs because the control system can react to a single input and make adjustments on that specific air main. In contrast, if there are multiple demands tapped into the same air main, adjusting the airflow to a single demand would modify the air flow to the other served demands on the same air main.

### Economic Benefit

The payback period for this practice is generally three to seven years for retrofits and about one year for new construction.

### Energy Savings

Savings of 20 to 40 percent of total aeration system energy consumption are typical.

### Applications & Limitations

This best practice applies to all aerated unit process treatment systems.

### Practical Notes

This best practice should be implemented at all facilities with aeration opportunities unless there is an overwhelming reason to avoid it.

### Other Benefits

This practice can result in improvement in other unit treatment processes on site and reduced maintenance at some facilities.

### Stages of Acceptance

The practice is beneficial because of the positive process results and reduction in energy use, but the primary obstacle to acceptance is the payback period, which varies depending upon the individual facility.

## WW15 — SLUDGE: IMPROVE SOLIDS CAPTURE IN DISSOLVED AIR FLOTATION (DAF) SYSTEM

The utility should optimize the air-to-solids ratio in a dissolved air flotation (DAF) system by adjusting the supply air and/or by feeding the highest possible solids content. Furthermore, the utility can reduce energy use by operating the DAF thickener continuously and adding polymers to the biosolids.

### See Also

Not applicable

### Primary Area/ Process

DAF thickeners are used in sludge thickening and dewatering processes.

### Productivity Impact

No impact

### Economic Benefit

DAF thickeners have high operating costs because they require a significant amount of energy for air pressurization. Payback for this practice will vary depending on the degree of optimization.

### Energy Savings

Energy consumption can be reduced by improving solids capture. The savings will depend on the application.

### Applications & Limitations

Continuous operation of the DAF thickener and the addition of polymers can increase the utility's O&M or labor costs.

### Practical Notes

The utility should compare the cost of the additional polymer with the avoided energy cost to determine if the polymer addition is worthwhile.

### Other Benefits

Improved solids capture will benefit other downstream biosolids treatment processes (i.e. thickening and/or dewatering).

### Stages of Acceptance

This practice is widely accepted by the industry.

## WW16 — SLUDGE: EVALUATE REPLACING CENTRIFUGE WITH SCREW PRESS

The utility should consider replacing the biosolids dewatering centrifuge with a screw press.

### See Also

WW17 – Sludge: Consider Replacing Centrifuge with Gravity Belt Thickener

### Primary Area/ Process

This practice affects biosolids thickening and dewatering processes.

### Productivity Impact

Minimal impact during installation

### Economic Benefit

Payback for this practice will depend on the size of the centrifuge being replaced.

### Energy Savings

This best practice has the potential for high energy savings, but savings will vary depending on the size of the centrifuge being replaced.

### Applications & Limitations

A centrifuge is a relatively large energy consumer. Replacing a centrifuge with a screw press reduces energy consumption. This reduction results from the simple, slow-moving mechanical equipment that uses gravity drainage to dewater the biosolids. The primary disadvantages of a screw press include the potential for increased odor problems and the larger space requirements for equipment. Biosolids thickening improves energy efficiency in biosolids digestion, dewatering, and disposal. The screw press produces a biosolids mass with a lower solids concentration than from a centrifuge. In selecting a biosolids treatment method, the utility should compare the life cycle costs of alternatives to identify the most cost-effective option.

### Practical Notes

When considering biosolids dewatering equipment, it is more efficient to select the smallest equipment that will satisfy the dewatering requirements and allow for continuous operation, than to install oversized equipment that operates for only a few hours per day.

This option can reduce energy consumption in two ways: First, any biosolids that are held in liquid form before dewatering will need to be agitated or aerated, processes which each require unnecessary energy consumption; second, smaller dewatering equipment will require smaller motors.

Biosolids cake storage and transportation requirements must be addressed prior to transitioning to 24-hour biosolids dewatering operations.

## Other Benefits

In addition to using less energy, the screw press has lower operation and maintenance costs than a centrifuge. Furthermore, a screw press can produce Class A biosolids if modified (by adding heat).

## Stages of Acceptance

Screw presses have been widely adopted for biosolids dewatering.

## WW17 — SLUDGE: CONSIDER REPLACING CENTRIFUGE WITH GRAVITY BELT THICKENER

The utility should consider replacing the centrifuge with a gravity belt thickener for improved biosolids thickening.

### See Also

WW16 – Biosolids: Evaluate Replacing Centrifuge with Screw Press

### Primary Area/ Process

This practice affects biosolids thickening and dewatering processes.

### Productivity Impact

Minimal impact during installation

### Economic Benefit

Payback for this practice will depend on the scale of the application.

### Energy Savings

This best practice has the potential for high energy savings, but savings will vary depending on the scale of the application.

### Applications & Limitations

A gravity belt thickener consists of a gravity belt driven by a motor. As the sludge moves forward on the horizontally-moving belt, water drains through the porous belt. The biosolids are continuously turned to improve the drainage process. Biosolids thickening reduces energy consumption in biosolids digestion, dewatering, and disposal. In selecting a biosolids treatment method, the utility should compare the life cycle costs of alternatives in order to identify the most cost-effective option.

### Practical Notes

None

### Other Benefits

Other advantages associated with gravity belt thickeners include smaller space requirements than other technologies and ease of automation and control.

### Stages of Acceptance

Gravity belt thickeners are a widely accepted option for biosolids thickening.

## WW18 — BIOSOLIDS DIGESTION OPTIONS

When planning new facilities or the expansion of an existing facility, the utility should assess the energy and production impacts of various biosolids processing options:

- Aerobic digestion: Standard aerobic digestion of biosolids is energy-intensive compared to fine-bubble diffusion with dissolved oxygen control and a variable air-flow rate blower. Some facilities currently turn off the air flow to the digester over extended periods of time, further reducing energy consumption.
- Anaerobic digestion: Anaerobic digestion requires detailed assessment by the utility to determine if this is a viable option. While the capital cost of an anaerobic digestion system is considerably greater than an aerobic system, an anaerobic system will consume less energy and has the potential to produce biogas for energy production over the lifetime of the system to help offset the initial capital costs.

The utility should consider both systems. If the plant treats over 5 MGD, anaerobic digestion is normally optimal; for plants that treat less than 1MGD, aerobic digestion can be optimal. In either case, all options should be considered.

### See Also

WW12 – Aerobic Digestion Options  
WW23 – Sidestream Deammonification  
WW24 – Optimize Anaerobic Digester Performance

### Primary Area/ Process

This practice applies to biosolids treatment and management.

### Productivity Impact

For each process, the utility should assess the energy impacts of recycling supernatant to evaluate their impacts on the treatment process.

### Economic Benefit

Payback will vary considerably from facility to facility and should be determined on a system-specific basis.

### Energy Savings

The utility should consider both aerobic and anaerobic systems to determine the most energy-efficient option. Savings will vary considerably from facility to facility.

### Applications & Limitations

Each facility must decide the class of biosolids it wants to produce, which will determine the type of biosolids treatment required. The utility must address whether the waste being treated is a high organic (BOD) concentration, irrespective of hydraulic flow, which may require the application of anaerobic treatment to economically reduce the waste strength.

### Practical Notes

Operators should include all facility-specific parameters in assessing treatment options, particularly the amount of energy consumed and produced by each process.

## Other Benefits

Both aerobic and anaerobic digestion systems will affect the characteristics of the solids product, which can affect the solids production rate and improve the facility's thickening and dewatering capabilities.

## Stages of Acceptance

Both aerobic and anaerobic biosolids digestion are readily available and widely accepted treatment processes.

## WW19 — BIOSOLIDS MIXING OPTIONS IN AEROBIC DIGESTERS

Biosolids mixing is an energy-intensive task that should be assessed alongside aerobic digestion considerations. Mixing is generally provided by aeration, mechanical mixing, pumping or a combination of these methods. Aeration of the biosolids mass is required to reduce volatile solids and control odor, but aeration may not be the most energy-efficient option for providing complete mixing in a digester, especially if constant oxygen is not required.

The utility should evaluate the energy costs of available options to determine the most energy-efficient technology that is appropriate for the facility's operations. A combination of mixing methods that will permit the system to be completely turned off periodically may be the most practical and energy-efficient option.

### See Also

WW12 – Aerobic Digestion Options

### Primary Area/ Process

This practice applies to all aerobic digestion systems.

### Productivity Impact

Minimal impact during installation and start-up.

### Economic Benefit

The payback period for a retrofit condition will typically range from one to three years. Payback for a new installation may take only one year.

### Energy Savings

The potential energy savings will vary by application but can be as high as 50 percent.

### Applications & Limitations

The limiting factor of this practice is the solids concentration in the aerobic digester.

### Practical Notes

The solids concentration of the digester contents should be controlled to an approximate maximum total suspended solids concentration of 2.5 percent.

### Other Benefits

This practice also improves volatile solids reduction, resulting in a reduction of the volume of biosolids for disposal.

### Stages of Acceptance

Mixing technologies, including the combination of a mixing regime and an aeration methodology, is accepted by the wastewater industry.



## WW20 — BIOSOLIDS MIXING OPTIONS IN ANAEROBIC DIGESTERS

The contents of an anaerobic digester must be mixed for proper operation, the destruction of volatile suspended solids, and the production of biogas. Previously, mixing was generally accomplished by injecting biogas into the bottom of the digester and having it pass through the contents of the tank (similar to an airlift pump). Some facilities also constantly operate their circulation pumps and continually pump the contents of the tank to recirculate and mix the contents.

Present mechanical mixing options such as jet mixing or linear motion mixing are available to improve mixing, increase the level of volatile solids destruction, increase biogas production, and reduce energy consumption of the mixing process.

### See Also

WW24 – Optimize Anaerobic Digester Performance

### Primary Area/ Process

This best practice applies to the complete mixing of anaerobic digesters.

### Productivity Impact

Disruption in production should only occur during installation and when the biological environment evolves to make the anaerobic system function.

### Economic Benefit

Payback depends on whether the system is new construction or a retrofit of an existing system. The payback for a retrofitted system will take longer.

### Energy Savings

Energy savings will vary substantially depending on the specific facility conditions. The savings will also depend upon the extent of modifications required to beneficially utilize the biogas produced.

### Applications & Limitations

Mixing should be employed by all anaerobic digestion systems to maximize both volatile solids destruction and biogas production while reducing the volume of biosolids for disposal.

### Practical Notes

The utility should evaluate the various technologies for mixing to identify the best option. It is important to assess the quality and production potential of the generated biogas and explore its beneficial use.

### Other Benefits

Maximizing the production of biogas may provide a lucrative and self-sustaining renewable energy opportunity.

### Stages of Acceptance

Various mixing technologies are widely accepted throughout the industry.



## WW21 — RECOVER HEAT FROM WASTEWATER

The utility should assess the possibility for waste-water heat recovery to provide a feasible and renewable energy source for heating and a heat sink for cooling applications. Heat recovery technology can be installed in new systems or retrofitted into existing systems. The technology can be designed to improve the total energy balance of the wastewater system, and can also be paired with heat pumps for heating and cooling.



### See Also

Not applicable

### Primary Area/ Process

This best practice is primarily applied either when the raw wastewater enters the treatment facility or after final clarification. It can also be applied to higher-temperature discharges within the collection system. Heat can be removed and added at these points and the temperature of the wastewater does not have a negative impact on the downstream process or collection system.

### Productivity Impact

Minimal impact during installation

### Economic Benefit

The main economic benefits of this practice are energy-efficient heating and cooling. Payback times will vary depending on the extent and location of modifications required. A payback period of one to three years may be possible if only a heat exchanger is required.

### Energy Savings

Additional energy savings may be available through the inclusion of heat pumps in the system modifications. Including heat pumps may increase efficiency by 20 to 30 percent.

### Applications & Limitations

Outflow from the heat exchanger component of the system has to occur by gravity.

### Practical Notes

Heat exchangers come in six standard sizes that range from 50 to 250 kW (~850,000 BTU) for heating and from 50 to 500 kW (~140 RT) for cooling. Each opportunity must be assessed on its merits and site-specific conditions. The heat exchanger should be equipped with a fully-automated, mechanical self-cleaning system for minimal maintenance and maximum operational safety. For optimal maintainability, the system can include a bypass.

### Other Benefits

Application of this best practice provides the additional benefit of cooling down hot wastewater streams that are hard to treat biologically at higher temperatures.

### Stages of Acceptance

The technology is well-proven with several installations worldwide, but the opportunity is still unrealized by many.

## WW22 — ANOXIC ZONE MIXING OPTIONS

When it becomes necessary for a wastewater treatment facility to incorporate anoxic zones, the utility should determine the best technology and methodology). Many wastewater treatment facilities use their existing aeration system blower to mix their anoxic zones. While this method of mixing does work, other methods should be considered. For example, fractional-to-low-horsepower mechanical agitators can be used to mix the anoxic zones and usually have notably lower energy demands than utilizing the aeration system blower. Mechanical mixing will better manage the concentration of oxygen in the zone, because it generally does not incorporate air into the contents being mixed. In addition, avoiding use of the existing aeration system for anoxic zone mixing enables more effective control.

### See Also

Not applicable

### Primary Area/ Process

This practice applies primarily to mixing treatment tanks that are to remain anoxic.

### Productivity Impact

Interruption to operations should only occur during installation of the equipment and associated controls.

### Economic Benefit

Simple payback is usually in the three-to-five-year range depending on the size of the anoxic zone(s) to be mixed.

### Energy Savings

Overall savings will vary depending on the efficiency and size of the existing system to be retrofitted. Generally, the reduction in energy for the anoxic mixing system ranges from 25 to 50 percent.

### Applications & Limitations

Limitations will vary with the characteristics of the material being mixed. In general, the higher the concentration of solids being mixed, the greater the savings.

### Practical Notes

Mechanical mixing should be assessed to account for the level of mixing required for improved process control. The goal of mechanical mixing is to be void of oxygen (anoxic), not anaerobic. It is better to have mechanical mixing, because stirring the liquid keeps the solids in suspension. However, many wastewater facilities use their aeration system to mix the anoxic tank. By doing so, air (20 percent oxygen) is fed into the contents of the tank, making process control more challenging.

### Other Benefits

This practice reduces air flow rate required from a blower. In addition, if the air was previously provided by the aeration blower, this practice results in one fewer variable for a DO control system to account for in the aeration tank, and thereby improves the efficiency of the overall treatment system.

### Stages of Acceptance

Anoxic zones are becoming more prevalent at wastewater treatment facilities as nutrient removal limits are being required. As a result, assessing mixing options is an acceptable practice.

## WW23 — SIDESTREAM DEAMMONIFICATION

For facilities that include nutrient removal and/or anaerobic digestion, the utility should assess deammonification to determine if it is a viable option for treating sidestream wastewater.

The process combines the partial nitrification and deammonification processes using Anammox bacteria, and is mainly used in treating ammonia-laden return streams generated from the dewatering of anaerobically digested sludge. The technology can also be applied in treating streams that involve thermal hydrolysis processes, co-digestion, industrial effluents, and landfill leachate.

Regardless of its source, to be a candidate for deammonification a waste stream should have a low biodegradable COD (chemical oxygen demand) content relative to its ammonia nitrogen content. The technology is a viable option if the influent has a total COD-to-ammonia ratio of 1.0 or less.

### See Also

Not applicable

### Primary Area/ Process

This practice applies to the treatment of sidestream wastewater from dewatering facilities using anaerobic digesters.

### Productivity Impact

The recycle streams at wastewater facilities can represent 15 to 40 percent of the total nitrogen load entering the secondary treatment process. Treating the side stream using deammonification can have a significant impact on the main stream by saving a considerable amount of the energy used facility-wide for aeration and reducing the carbon requirements for total nitrogen (TN) removal in the secondary process. The amount of energy savings and the reduction in carbon requirements are dependent on the carbon-to-nitrogen ratio of the plant influent and the final effluent requirements.

### Economic Benefit

Based on conventional activated sludge for nitrification and denitrification, the deammonification process can save 60 percent of the energy required, 100 percent of the carbon required for denitrification, and 50 percent of the alkalinity required for nitrification. In addition, deammonification can reduce the overall sludge production of the facility as it eliminates the need for an external carbon source, which would otherwise generate sludge and require disposal.

### Energy Savings

This practice can result in savings of up to 60 percent of the energy required for standard nitrification.

## Applications & Limitations

Deammonification can be achieved with a single-reactor approach (also called single-stage deammonification, in which partial nitrification and anaerobic ammonia oxidation occur in the same reactor), or a two-reactor approach (also called two-stage deammonification, in which nitrification is achieved in a preceding reactor followed by an anaerobic ammonia oxidation reactor).

While both approaches have been successfully applied at full scale, industry understanding has developed in recent years to favor single-stage processes because of their simplicity and stability, as well as their ability to retain attractive volumetric efficiencies and easily retrofit into an existing basin.

In facilities with anaerobic digestion, sidestream deammonification can be applied for the following specific purposes:

- For high-rate wastewater treatment plants where reductions in plant effluent ammonia are desirable, it can reduce final effluent ammonia loads while avoiding costly upgrades to the mainstream secondary process.
- It can be used to enhance the plant's final effluent nitrogen and improve the stability of the biological phosphorus removal (BPR) process by improving the carbon-to-nitrogen ratio of the main-stream influent.

The major limitations of deammonification are that it requires influent with a low carbon-to-nitrogen ratio and high temperature, and the start-up can take as long as two to four months with seeding due to slow growth of Anammox bacteria.

## Practical Notes

This best practice should be implemented at all facilities with anaerobic digesters and total nitrogen (TN) limits.

## Other Benefits

Deammonification minimizes the impact of recycled nitrogen streams entering the main plant by treating the sidestream.

## Stages of Acceptance

While the first installation is approximately 10 years old, the number of total installations worldwide is close to 100. Deammonification is increasingly gaining acceptance in the United States, with seven installations under construction or in operation and many more in the design or planning stage.

## WW24 — BIOTOWER ENERGY EFFICIENCY

Biotowers (BT) or trickling filters (TF) are engineered systems that can provide cost-effective and energy-efficient treatment of municipal and industrial wastes. They can be designed for full treatment or as an initial (roughing) treatment for high-strength wastes. They are often teamed with activated sludge systems to provide tertiary treatment and/or preliminary treatment to reduce the amount of organics entering the aeration tank. The availability of PVC media has provided designers with media that has high compressive strength and identifiable void volumes so that a BT/TF can now be designed for specific treatment requirements.

BT/TFs require power for pumping the influent to be treated, and may include a drive to control the rotational speed of the distribution arm. Furthermore, power is consumed to recycle flows, provide flushing, and meet media wetting rates. Both pumping rates and distribution arm speed must be specified to indicate the most energy-efficient pumping range for operations. Variables range from minimum media wetting rates to maximum media flushing rates, with variable influent loadings that optimize flow according to wastewater organic characteristics. Assessing these variables and identifying the ideal balance should result in the most energy-efficient operation of a BT/TF system.

### See Also

G22 – Pumps: Reduce Pumping Flow  
G23 – Pumps: Reduce Pumping Head  
G24 – Pumps: Avoid Pump Discharge Throttling

### Primary Area/ Process

This best practice should be applied to all biotower and trickling filter installations.

### Productivity Impact

This measure will impact operation during installation.

### Economic Benefit

The estimated payback will vary with the extent of the modifications. The payback will depend on the avoided life cycle cost of energy versus the initial capital cost of the improvement.

### Energy Savings

Energy savings can vary greatly, with savings generally ranging from 15 to 30 percent of the present BT/TF energy consumption.

### Applications & Limitations

The application of this practice is usually limited to the BT/TF feed, recycle pumps, and the value of installing a drive on the distribution arm.

### Practical Notes

A detailed evaluation of the system is necessary to determine which components should be changed to provide an acceptable level of energy cost savings.

### Other Benefits

This practice results in reduced pump pressure and wear. Inclusion of a drive will provide better speed control of the distribution arm and will usually provide the opportunity to reduce pumping rates during operation, improving operational flexibility for the fixed media treatment process.

### Stages of Acceptance

As the industry embraces energy cost reduction opportunities, this best practice will become more acceptable.

## WW25 — OPTIMIZE ANAEROBIC DIGESTER PERFORMANCE

The utility should optimize anaerobic digester performance and enhance biogas production. The primary ways to optimize anaerobic digestion are:

**Optimization of process temperature:** Changing the digester operating temperature from mesophilic (85-105°F) to thermophilic (125-140°F) increases the rate of destruction of the volatile solids in the biosolids. Two-phased anaerobic digestion and temperature-phased digestion have shown potential benefits in volatile solids reduction and biogas production enhancement.

**Biosolids pre-treatment:** The hydrolysis step is often the limiting factor in anaerobic digestion. Hydrolysis can be improved by pre-treatment to improve the ability of the active microorganisms to digest the biosolids. There are various pre-treatment methods available, including chemical, physical, and biological methods. Three of the most promising methods include thermal treatment, ultrasonic treatment, and enzyme dosing.

**Co-digestion of auxiliary feedstock:** It is often beneficial to co-digest biosolids with other types of organic waste, such as restaurant grease, dairy/cheese wastes, vegetable/fruit waste, and municipal organic waste. By doing so, the nutrient and moisture content can be optimized, process stability can be improved, and biogas production can be enhanced.

**Pre-thickening of the biosolids:** The utility can pre-thicken biosolids being fed to the digester to reduce excess water. This will increase the residence time of volatile solids and lessen the amount of energy required to heat the biosolids fed to the digester.

### See Also

WW25 – Use Biogas to Produce Combined Heat and/or Power (CHP)

### Primary Area/ Process

This practice affects anaerobic sludge digestion.

### Productivity Impact

Minimal impact during installation

### Economic Benefit

The economic benefit of increased biogas production will be reduced by the cost of biosolids pre-treatment and biogas conditioning equipment that is necessary for biogas utilization. Acceptance of other waste may generate additional revenue for the wastewater treatment facility.

### Energy Savings

Energy savings will be proportional to the amount of additional biogas produced for power and/or heat generation.

### Applications & Limitations

Except for the capital costs of the biosolids pre-treatment and the biogas conditioning equipment, this practice has no limitations.



Practical Notes

Performance optimization of the anaerobic digester will benefit biosolids quality for downstream biosolids processing, treatment, and disposal.

Other Benefits

Not applicable

Stages of Acceptance

These optimization techniques are currently not widely used, but are gaining industry interest.

## WW26 — USE BIOGAS TO PRODUCE COMBINED HEAT AND/OR POWER (CHP)

Biogas produced by an anaerobic digester can drive reciprocating engines which can be directly connected to a pump, blower, or electric generator, or can fuel micro-turbines, turbines, or fuel cells to generate electricity. In addition, the thermal energy generated by these systems can often be captured and utilized to meet digester heat loads and, where applicable, for building heating. Alternatively, the biogas can be used directly as boiler fuel for the production of heat. In some limited applications biogas is even being utilized as vehicle fuel.

### See Also

WW24 – Optimize Anaerobic Digester Performance

### Primary Area/ Process

This practice applies to anaerobic sludge digestion.

### Productivity Impact

This practice has minimal impact during the installation of a CHP system.

### Economic Benefit

If sufficient biogas is available to fuel a combined heat and power (CHP) process that can generate electricity to operate the facility and capture heat to offset process needs, the facility may attain energy neutrality. Whether the system generates electricity or heat, or both, the internal use of the energy will offset energy utility bills.

### Energy Savings

Utilities should assess biogas-to-electricity generating systems for treatment facilities that have existing anaerobic digesters or are planning to install new ones. Each system needs to be individually assessed for feasibility.

### Applications & Limitations

The characteristics and quality of the biogas to be utilized must be assessed on a facility-by-facility basis to determine what level of biogas conditioning (clean up) is required for the beneficial, reliable, and non-harmful utilization in an engine, boiler, or process to be fueled. The utility should also determine the volume of biogas generated to assess the need for incorporating auxiliary feed stock for the digester to make biogas production viable.

### Practical Notes

Reciprocating engines can be used in a majority of facility sizes. Micro-turbines and fuel cells are available in smaller capacity sizes for small facilities, where emissions are a concern. Combustion turbines can be used for facilities with generating capacities shown to be greater than one megawatt. The utility should assess the potential to directly operate pumps or blowers using biogas to identify the most beneficial utilization option for the site.

### Other Benefits

Collecting and using biogas avoids venting and flaring, which release greenhouse gases. Beneficial utilization of biogas can also help a facility become self-sustaining.

### Stages of Acceptance

Combined heat and power systems are gaining acceptance and being increasingly implemented in the wastewater industry.



## WW27 — BIOGAS: ASSESSMENT OF BENEFICIAL UTILIZATION

Biogas is a renewable energy resource the utility should consider as a source of energy to fuel the facility's boilers, to directly fuel an engine to drive a piece of equipment, and/or to generate electricity. Analysis of an anaerobic digestion system's biogas production potential requires a different view—one that looks to maximize energy production rather than minimize energy use as with other energy efficiency practices. The assessment should consider biogas production from initial operation through the end of its life cycle, helping utility personnel to understand the beneficial utilization over the system's lifetime.

Assuming that system loads grow over the lifetime of the equipment, initial loadings will be less than design conditions. Since the capital investment of the biogas utilization system must be repaid over the design life, an analysis of the projected biogas generation must show that the life cycle benefits outweigh the initial cost. An analysis showing how the anaerobic digester will be loaded over its lifetime should show how operation will be optimized on the overall system economics. Once the rate of biogas production has been estimated, the assessment should address options for the lifetime utilization of the biogas. A full analysis will also consider the quality of the biogas available and the potential need for special conditioning equipment. The type and size of gas conditioning equipment should be specified.

The presence of biogas production that is capable of meeting both the internal electric needs of the facility and the process heating needs is not unusual. Biogas used for process heating has a conversion efficiency of 80 to 85 percent. Conversion to electricity can be done at a rate of 30 to 35 percent. If both heat and power are generated, the conversion efficiency will generally range from 70 to 75 percent.

### See Also

WW18 – Biosolids Digestion Options  
 WW20 – Biosolids Mixing Options in Anaerobic Digesters  
 WW24 – Optimize Anaerobic Digester Performance  
 WW25 – Use Biogas to Produce Combined Heat and/or Power (CHP)

### Primary Area/ Process

This practice applies to anaerobic digestion.

### Productivity Impact

Minimal impact during installation

### Economic Benefit

The economic benefit is in the opportunity to offset the facility's electric and natural gas use through the utilization of an otherwise flared-off renewable energy resource.

### Energy Savings

The amount of energy savings will depend on the quantity and quality of the biogas and how much can be utilized. At some wastewater treatment facilities the utilization of internally generated biogas has been sufficient to eliminate facility's reliance on purchased energy.



## Applications & Limitations

The beneficial utilization of biogas should be implemented, when feasible, at all wastewater treatment facilities with anaerobic digestion. Many biogas systems have failed due to the improper treatment of the impurities in the biogas, resulting in poor operation and system breakdown. Biogas utilization should always use gas conditioning equipment.

## Practical Notes

Biogas utilization must incorporate biogas conditioning to ensure the system being fueled does not become impaired because of varying biogas characteristics.

## Other Benefits

The utilization of biogas can assist the facility in moving toward energy neutrality and help in reducing greenhouse gas emissions (methane and carbon dioxide).

## Stages of Acceptance

The utilization of biogas is gaining acceptance and being implemented more frequently across the industry.



# BEST PRACTICES BUILDINGS

THIS PAGE INTENTIONALLY LEFT BLANK



# BUILDING BEST PRACTICES

## MONITORING AND CONTROLS

**B1** Monitor Lighting Operation Page 139

## MAINTENANCE

**B2** Clean Lamps and Fixtures Page 140

**B3** Properly Maintain Outside Air Ventilation Devices and Ventilation Supply Fans Page 141

**B4** Replace Ventilation Air Filters Page 143

## MEASURES

**B5** Install VFD Control on Air Compressors Page 144

**B6** Install High-Efficiency Lighting and Advanced Controls Page 145

**B7** Evaluate Existing HVAC Systems for Re-Commissioning or Replacement Page 147

## PLANNING AND DESIGN

**B8** Evaluate Projects for Potential LEED Certification Page 148

THIS PAGE INTENTIONALLY LEFT BLANK



# Building Best Practices



The following table shows the typical energy savings and payback periods for the Best Practices found in this section, grouped by category, and includes three blank columns for you to complete as you analyze each practice. You can utilize this checklist to track the process of reviewing these Best Practices and note which ones are feasible for your utility and which ones need further review.

Best Practices	Typical Energy Savings of Unit of Process (%)	Typical Payback Years	Best Practice Feasible? (Yes/No)	Date Analyzed	Further Review Needed? (Yes/No)
<b>Monitoring and Controls</b>					
B1 - Monitor Lighting Operation	15 - 90	Variable			
<b>Maintenance</b>					
B2 - Clean Lamps and Fixtures	Variable	Variable			
B3 - Properly Maintain Outside Air Ventilation Devices and Ventilation Supply Fans	Variable	Variable			
B4 - Replace Ventilation Air Filters	Variable	Variable			
<b>Measures</b>					
B5 - Install VFD Control on Air Compressors	Variable	Variable			
B6 - Install High-Efficiency Lighting and Advanced Controls	10 - 30	< 4			
B7 - Evaluate Existing HVAC Systems for Re-Commissioning or Replacement	Variable	Variable			
<b>Planning and Design</b>					
B8 - Evaluate Projects for Potential LEED Certification	Variable	Variable			

THIS PAGE INTENTIONALLY LEFT BLANK

## B1 — MONITOR LIGHTING OPERATION

Manually switching off lights is one of the best no-cost methods of saving lighting energy. Facility staff should be made aware of how to turn on and off all lights and signage, with the exception of security lights and exit signs, and should be instructed to turn lights off when daylight is sufficient or they are not needed. Occupancy sensors use various detection technologies to turn off lights in unoccupied areas, and can potentially be installed in conference rooms, restrooms, storage areas, and other spaces prone to intermittent occupancy that have lighting that is left on.

See Also	Not applicable
Primary Area/ Process	This practice can be applied to lighting in areas that have intermittent or low personnel usage.
Productivity Impact	No impact
Economic Benefit	Occupancy sensors are relatively inexpensive, with installation costs typically ranging from \$50 to \$150 per sensor, and can have a significant impact on energy savings.
Energy Savings	Typical energy savings from occupancy sensors range from 15 to 90 percent, depending on type and use of space. For example, occupancy sensors integrated with bi-level fluorescent lighting can provide substantial energy savings in hallways, stairwells, and storage areas.
Applications & Limitations	This practice has limited application in high-traffic areas due to excess cycling of lighting fixtures, which can decrease fixture life expectancy. In addition, the utility should bear in mind that unilaterally installing occupancy sensors without understanding the use of the space can lead to spending unnecessary additional capital.
Practical Notes	None
Other Benefits	Not applicable
Stages of Acceptance	This practice is widely accepted.

## B2 — CLEAN LAMPS AND FIXTURES

Facility lighting fixtures and lamps should be washed on a regular schedule using the proper cleaning solution to avoid the accumulation of dirt, which can result in a decrease of light output ranging from 5 to 50 percent. The frequency of cleaning required depends on the amount and type of dirt in the air, whether the fixture is of the ventilated or non-ventilated type, and the location of the lighting fixture. Older-style fluorescent lamps last as little as three years; therefore, it may not be necessary to clean between lamp replacements. Newer fluorescent lamps can last up to 10 years and therefore, must be cleaned regularly. Frequent cleaning may be required if the room is exposed to large amounts of dust and grease, if the lamps are directed upward without protection from falling dust, or if the lighting is outside. Many luminaires initially provide the same illumination level, but its ability to be economically maintained and to preserve maximum effectiveness is dependent on quality and appropriateness. Selecting the appropriate fixtures for a specific location or application can reduce the need for cleaning or simplify the cleaning process, improving the longevity and overall effectiveness of the lighting.

See Also

Not applicable

Primary Area/  
Process

This practice applies to all lighting at the facility.

Productivity  
Impact

Cleaner fixtures provide better lighting output and brighter spaces, which can increase productivity.

Economic  
Benefit

This practice can ensure that the fixtures remain in service for the duration of its expected life, which can save capital funding for when full replacements are necessary.

Energy Savings

None

Applications &  
Limitations

Most normal maintenance procedures call for lamps and fixtures to be cleaned on an annual basis, but that may be difficult to accomplish with limited staff.

Practical Notes

None

Other Benefits

Not applicable

Stages of  
Acceptance

This practice is well-accepted.

## B3 — PROPERLY MAINTAIN OUTSIDE AIR VENTILATION DEVICES AND VENTILATION SUPPLY FANS

The utility should regularly check outside air ventilation devices as well as ventilation/supply fans and perform any routine maintenance that the equipment requires.

Many ventilation systems use outside air economizer dampers that automatically modulate the amount of outside airflow used to condition the space. These economizers allow up to 100 percent of outside air for free cooling during moderate outdoor conditions, but restrict the outside airflow to a minimum setting when it is too cold or hot outside for beneficial use. Outside air dampers and economizer cycles can have reliability problems if the outside air damper becomes stuck open (in which case too much outside air may enter the system and the cooling coils can be overloaded) or stuck closed (in which case the facility may not get the proper air changes). The utility should regularly clean and lubricate the movable parts and periodically check the actuator movement to ensure proper operation and to maintain maximum system efficiency.

Additionally, ventilation/supply fans require routine maintenance for optimal operation. It is necessary to lubricate bearings, adjust or change fan belts, and clean fan blades on an annual basis to maximize fan efficiency.

See Also

Not applicable

Primary Area/  
Process

This process applies to any outside air ventilation devices at a facility.

Productivity  
Impact

No impact

Economic  
Benefit

This practice can have significant impact on equipment function and provide simple, cost-effective energy savings.

Energy Savings

This practice can provide significant energy savings.

Applications &  
Limitations

The main purpose of a ventilation system in a wastewater treatment plant is to supply sufficient outside ventilation air for the dilution of odor-causing contaminants, such as hydrogen sulfide and ammonia. The discharge from the ventilation system is typically treated by vapor phase systems, including wet air scrubbing and carbon adsorption. If large amounts of air are ventilated, vapor-phase systems can also be effective at providing adequate ventilation for occupancy. The ventilation system also plays an important role in conditioning the interior space.

Practical Notes

None

Other Benefits

Not applicable

Stages of  
Acceptance

This process is well-accepted.

## B4 — REPLACE VENTILATION AIR FILTERS

The utility should replace old or outdated filters in the facility’s ventilation system in order to improve the system’s energy efficiency.

The ventilation system removes particulates contained in outside air by way of air filters. Particulate accumulation on air filters reduces airflow and increases fan energy consumption. The use of modern air filters improves indoor air quality while reducing the total cost of operation if the system is using VFD technology. The cost of the filter is relatively inexpensive compared to the cost of the fan energy that is required to push the air through the dirty filter. The energy cost savings can be significant to justify the cost to upgrade to a new filter. The most common improvement is to replace two-inch pleated filters with four-inch extended service pleated filters.

See Also	Not applicable
Primary Area/ Process	This practice can be applied to any building at the utility that utilizes a ventilation system.
Productivity Impact	No impact
Economic Benefit	Replacing old air filters increases airflow while reducing the fan energy consumption, which reduces energy cost.
Energy Savings	Energy savings for this practice can be significant if filters are old and not allowing air through.
Applications & Limitations	No limitations
Practical Notes	None
Other Benefits	In addition to saving energy, replacing old filters will also improve air quality at the facility.
Stages of Acceptance	This practice is widely accepted.

## B5 — INSTALL VFD CONTROL ON AIR COMPRESSORS

Compressors produce low volumes of air at 80 to 140 psi. Many utilities have rotary screw type air compressors that use inlet modulation with unloading for part-load control. In this setup, the air compressor produces compressed air until a desired value is reached, at which point it begins modulating and then unloads. When it unloads, the air compressor continues rotating until the maximum pressure value is reached. This mode is highly inefficient because it still requires about 20 percent of the compressor's full electrical load. To save energy, especially in part-load operation, the utility should consider installing VFDs on a rotary screw air compressor in place of inlet modulation with unloading.

### See Also

G18 – Electric Motors: Variable Frequency Drives Applications

### Primary Area/ Process

This practice affects any component of the treatment process that includes air compressors, which are commonly used to provide air to pneumatic actuators and operate air diaphragm pumps.

### Productivity Impact

VFD-controlled air compressors provide air at a more constant pressure, which can increase productivity.

### Economic Benefit

Payback for this best practice depends on the operating hours and size of the compressor.

### Energy Savings

Energy savings for this best practice depend on the operating hours and size of the compressor.

### Applications & Limitations

No limitations

### Practical Notes

None

### Other Benefits

None

### Stages of Acceptance

The use of VFDs on air compressors is widely accepted by the industry.



## B6 — INSTALL HIGH-EFFICIENCY LIGHTING AND ADVANCED CONTROLS

Utilities should assess opportunities for installing high-efficiency lamps and advanced lighting controls to increase energy efficiency in individual fixtures as well as the overall lighting system.

Options include:

- **Energy-efficient lamps/fixtures:** The primary replacement option is the Light Emitting Diode (LED). The quality, reliability, and cost of this type of lighting make it a viable alternative to incandescent, high-intensity discharge (HID), and T-12 fluorescent fixtures/ lamps. However, in many cases a more suitable option may be energy-efficient fluorescent lighting with high-efficiency ballasts. Compact fluorescent lighting (CFLs) is included in this category. Several of these options include technologies that will work for outside and severe condition environments.
- **Advanced lighting controls:** These include multi-level lighting that is controlled by motion, ambient day light, timers, or a combination of these elements. Advanced lighting controls can improve the overall efficiency of the lighting system, and should be considered in all lighting retrofit and new construction projects.

See Also

Not applicable

Primary Area/  
Process

This practice should be assessed for potential application in all buildings across the utility, including office spaces, hallways, treatment facilities, and parking lots.

Productivity  
Impact

Lighting quality can have significant positive impacts on productivity, due to increased visibility for employees.

Economic  
Benefit

Payback for this practice depends on the number and type of lights and controls being installed/replaced and is typically less than four years. With increasing product lifetimes and lower initial costs, LED projects are becoming more viable.

Energy Savings

Energy savings depend on the number and type of lights being replaced, but typical lighting projects can reduce the electrical lighting energy needed by 30 percent or more. Efficiency improvement approaching 70 percent has been documented in the case of LED lighting with advanced controls. The long operating hours of exterior fixtures can yield significant energy savings and low paybacks.

## Applications & Limitations

Lighting intensity levels should be maintained or increased, depending on needs. Compliance with all electric code requirements should be fulfilled regarding fixture type, location, and the ambient conditions of the fixture location.

Look for the ENERGY STAR® label, Consortium for Energy Efficiency (CEE), or DesignLights Consortium (DLC) qualified fixtures when selecting replacement lighting. These qualifications are meant to denote reputable and high quality products. They are also a frequent requirement in utility or municipal rebate programs.

## Practical Notes

Lighting projects usually have a short simple payback period and can often be used to help finance additional energy work.

## Other Benefits

Not applicable

## Stages of Acceptance

The installation of high-efficiency lighting fixtures and controls is generally accepted.

## B7 — EVALUATE EXISTING HVAC SYSTEMS FOR RE-COMMISSIONING OR REPLACEMENT

Most buildings associated with water and wastewater treatment require some type of heating, ventilation, and air conditioning (HVAC) system. These systems can add to the inefficiency of the overall facility, and the utility should regularly inspect its HVAC system to determine if the equipment needs to be either re-commissioned or considered for replacement with more energy-efficient units.

Re-commissioning consists of an overall evaluation and adjustment of the system to ensure it is operating properly and to design conditions. Depending on the configuration of the building and existing HVAC system, there are several options for replacement. Variable refrigerant flow (VRF) split systems are very energy-efficient under part-load conditions, as they deliver air conditioning to different areas within a building based on that area's actual cooling requirement. Other options include energy-efficient unitary or rooftop units. Even window units should be evaluated for replacement with ENERGY STAR® rated equivalent units.

See Also	Not applicable
Primary Area/ Process	This practice can be applied at all facilities that require HVAC.
Productivity Impact	Properly sized and selected HVAC systems that are operating as designed can provide a more energy-efficient and comfortable working environment, which tends to increase productivity.
Economic Benefit	Having a properly designed and operated HVAC system can provide savings in operational, maintenance, and utility costs. Simple payback will depend on the size and condition of the existing system. On average, paybacks for HVAC system replacement projects are usually between four to eight years.
Energy Savings	Energy savings will vary based on current condition and type of the existing HVAC system. Re-commissioning can provide energy savings of 10 - 20 percent.
Applications & Limitations	None
Practical Notes	HVAC systems should be properly maintained throughout the life of the unit to ensure optimal performance and efficiency.
Other Benefits	Not applicable
Stages of Acceptance	This practice is widely accepted.

## B8 — EVALUATE PROJECTS FOR POTENTIAL LEED CERTIFICATION

Utilities should consider the standards set forth by the Leadership in Energy and Environmental Design (LEED) Green Building Rating System in the design of any new construction or major renovation projects, and should apply for LEED certification when appropriate.

The LEED Green Building Rating System is a voluntary, consensus-based national rating system for developing high-performance, sustainable buildings. LEED addresses all building types and emphasizes state-of-the-art strategies in five areas: sustainable site development, water savings, energy efficiency, materials and resources selection, and indoor environmental quality. Projects typically will need to involve energy efficiency measures in order to qualify for LEED certifications. Whether for new construction or major renovation, LEED certification should be considered as a possible alternative to standard design.

See Also

Not applicable

Primary Area/  
Process

This practice affects all areas of building construction, location, and energy use. LEED is a comprehensive energy approach and uses many measures and standards from the American Society of Heating, Refrigerating and Air-Conditioning Engineers (ASHRAE) and other code sources within its best practices.

Productivity  
Impact

No impact

Economic  
Benefit

The economic benefit of this practice is proportional to the energy savings achieved.

Energy Savings

Recent studies have found that on average, LEED certified buildings are more energy-efficient than standard-design buildings. The level of energy efficiency (and thus the amount of savings) varies depending on location, orientation, and other factors, so due diligence is required by engineers and consultants when deciding to apply.

Applications &  
Limitations

The utility should assess any planned projects to determine whether applying for LEED certification is appropriate and valuable.

Practical Notes

None

Other Benefits

Not applicable

Stages of  
Acceptance

LEED certification is starting to receive wide levels of acceptance.

# Baseline Energy Use and Key Performance Indicators (KPI)

## APPENDIX A

An effective Energy Management Team will emphasize the use of system data to make decisions regarding capital investments and operational changes. This method provides a model and procedure for any utility to collect, develop, and analyze this critical data.

### SELECT KEY PERFORMANCE INDICATOR (KPI) FOR ENERGY USAGE

By itself, saving energy is a benefit in that it reduces operational costs. However, as a business you are responsible for performing a key task for the community, such as treating water to make it safe and drinkable or treating wastewater to make the effluent safe for the environment. Therefore, energy savings must be indexed against the production of the core business production units, such as millions of gallons per day (MG) or pounds of biological oxygen demand (BOD) reduced, e.g. kWh/MG or kWh/lb BOD.

A Key Performance Indicator, known also as an Energy Performance Indicator (EPI), shows how your energy use changes with time as you change equipment and modify operational procedures. The data collected and analyzed at any given time represents a snapshot of energy performance.

The following discussion shows how you can develop your facility's baseline and use it as a tool to track your KPI and compare it with your selected benchmarks and goals.

### BASELINE DEVELOPMENT

The following pages are tables, sequenced according to the tasks you should perform in developing your current energy use as a function of your production. The tables for Steps 2 through 4 are populated with sample data to give you an idea of how this is done.

#### DATA COLLECTION TEMPLATE

##### STEP 1

The first table is a blank sheet that can help you plan your data collection efforts. It identifies what data you need to collect so that you can organize your next steps. You may want to add lines for additional equipment, e.g. if you deploy several pumps of varying size for raw wastewater pumping, you can label them Pump 1, Pump 2, etc.

## GATHER UNIT RATINGS

### STEP 2

Once your data collection plan is ready, you can begin to collect the data needed to fill in the blanks. You will record nameplate data for the key equipment that you want to include. Under the horsepower or kW ratings, you should also indicate the loadings, if not fully loaded. Motors are often partially loaded and, in those cases, using the full rating would not reflect actual energy use.

## GATHER OPERATIONS DATA

### STEP 3

In addition to gathering unit ratings, you may also be able to collect operations data, including hours of operation (per day, week, or year). You may need to estimate the hours, based upon your knowledge of the operation of the equipment.

## CALCULATE ENERGY USE

### STEP 4

The final two columns allow you to calculate the estimated annual energy use for the equipment in the given row. This value represents the specific baseline for that particular piece of equipment. After you've gathered all of the equipment data you need, you can then calculate the percent of contribution to total energy load that each piece of equipment represents.

At the bottom of the table for Step 4, the total facility energy use is summed. Coupled with your facility's production data, you can also calculate your baseline KPI, as shown. This represents an estimate of your facility's energy use, accounting for major equipment. When you compare it with your annual utility bill, it will likely be less, due to unaccounted-for uses, such as computers, lighting, and HVAC. Nonetheless, the estimated KPI gives you a solid indication of your process energy use.

Also from Step 4 you will have the energy use (kWh) and percent of total facility energy use each component consumed. You can then compare these values to general industry values to identify if any specific piece of equipment or process is using notably more energy than it should be using. When this is identified you then can initiate action, perform wire-to-water or wire-to-air (blower) or wire-to-product analysis, to individually assess each piece of equipment or aggregate the energy use to represent the total process energy to determine if energy efficiency opportunities exist.

## SETTING YOUR KEY PERFORMANCE INDICATOR (KPI) GOAL



Whether you want to call it a benchmark or goal, your KPI goal is a target that includes a time limit. For example, you may want to save five percent of your energy consumption within one year. Your KPI target becomes 95 percent of your current KPI, which you just estimated. Or, if your KPI is higher than your industry benchmark, as indicated in Section 1, you may want to use the appropriate industry benchmark as your KPI target. Either way, the industry benchmarks in Section 1 are a good way to compare your facility's performance.

Once you've set your KPI goal, you can begin to measure the impacts of your capital and operational improvements, which ultimately enables you to translate these values into cost savings for your facility.

STEP 1 – Data Collection Template	# Units	HP of Unit	kW of Unit	# Units in Operation	Hrs/Yr in Operation	Estimated Energy Use kWh/yr	% of Total
Raw Wastewater Pumps							
Fine Screens							
Fine Screen Conveyor							
Grit Removal							
Grit Pumps							
Primary Settling Basins							
Primary Sludge Pumps							
Aeration Blowers - PD							
Aeration Blowers - Centrifugal							
Secondary Settling							
Return Activated Sludge Pumps							
Waste Activated Sludge Pumps							
Disinfection System							
Final Effluent Peak Pumps							
Primary Sludge Thickening							
Anaerobic Digester Circulation Pumps							
Anaerobic Digester Mixing							
Belt Press							
Odor Control							
Effluent Reuse Pumps							
Sludge Transfer Pumps							
WWTF Compressed Air System							

STEP 2 Gather Unit Ratings	# Units	HP of Unit	kW of Unit	# Units in Operation	Hrs/Yr in Operation	Estimated Energy Use kWh/yr	% of Total
Raw Wastewater Pumps	3	200	149.2				
Fine Screens	3	1.5	1.1				
Fine Screen Conveyor	1	1.5	1.1				
Grit Removal	2	2	1.5				
Grit Pumps	2	10	7.5				
Primary Settling Basins	4	2	1.5				
Primary Sludge Pumps	2	20	14.9				
Aeration Blowers - PD	4	250	186.5				
Aeration Blowers - Centrifugal	4	300	223.8				
Secondary Settling	4	2	1.5				
Return Activated Sludge Pumps	4	50	37.3				
Waste Activated Sludge Pumps	3	10	7.5				
Disinfection System	1		130				
Final Effluent Peak Pumps	4	100	74.6				
Primary Sludge Thickening	4	10	7.5				
Anaerobic Digester Circulation Pumps	4	15	11.2				
Anaerobic Digester Mixing	6	10	7.5				
Belt Press	1	10	7.5				
Odor Control	1	50	37.3				
Effluent Reuse Pumps	1	10	7.5				
Sludge Transfer Pumps	2	20	14.9				
WWTF Compressed Air System	2	30	22.4				



STEP 3 Gather Operations Data	# Units	HP of Unit	kW of Unit	# Units in Operation	Hrs/Yr in Operation	Estimated Energy Use kWh/yr	% of Total
Raw Wastewater Pumps	3	200	149.2	1.5*	8,760		
Fine Screens	3	1.5	1.1	2	2,190		
Fine Screen Conveyor	1	1.5	1.1	1	2,190		
Grit Removal	2	2	1.5	2	8,760		
Grit Pumps	2	10	7.5	2	2,190		
Primary Settling Basins	4	2	1.5	4	8,760		
Primary Sludge Pumps	2	20	14.9	4	2,190		
Aeration Blowers - PD	4	250	186.5	1	8,760		
Aeration Blowers - Centrifugal	4	300	223.8	3	8,760		
Secondary Settling	4	2	1.5	4	8,760		
Return Activated Sludge Pumps	4	50	37.3	4	8,760		
Waste Activated Sludge Pumps	3	10	7.5	2	2,190		
Disinfection System	1		130	1	4,380		
Final Effluent Peak Pumps	4	100	74.6	1	350		
Primary Sludge Thickening	4	10	7.5	4	350		
Anaerobic Digester Circulation Pumps	4	15	11.2	4	8,760		
Anaerobic Digester Mixing	6	10	7.5	4	8,760		
Belt Press	1	0	7.5	1	2,920		
Odor Control	1	50	37.3	1	8,760		
Effluent Reuse Pumps	1	10	7.5	1	4,380		
Sludge Transfer Pumps	2	20	14.9	1	2,080		
WWTF Compressed Air System	2	30	22.4	1	8,760		

\* The 1.5 represents one pump operating continuously (8760 hrs/yr) and a second pump operating during higher influent flow (daily diurnal flows and wet weather conditions) for 4380 hrs/yr or 0.5 equivalence.

# APPENDIX A

STEP 4 Calculate Energy Use	# Units	HP of Unit	kW of Unit	# Units in Operation	Hrs/Yr in Operation	Estimated Energy Use kWh/yr	% of Total
Raw Wastewater Pumps	3	200	149.2	1.5	8,760	1,960,488	15.10%
Fine Screens	3	1.5	1.1	2	2,190	4,818	0.04%
Fine Screen Conveyor	1	1.5	1.1	1	2,190	2,409	0.02%
Grit Removal	2	2	1.5	2	8,760	26,280	0.20%
Grit Pumps	2	10	7.5	2	2,190	32,850	0.25%
Primary Settling Basins	4	2	1.5	4	8,760	52,560	0.40%
Primary Sludge Pumps	2	20	14.9	4	2,190	130,524	1.00%
Aeration Blowers - PD	4	250	186.5	1	8,760	1,633,740	12.58%
Aeration Blowers - Centrifugal	4	300	223.8	3	8,760	5,881,464	45.29%
Secondary Settling	4	2	1.5	4	8,760	52,560	0.40%
Return Activated Sludge Pumps	4	50	37.3	4	8,760	1,306,992	10.06%
Waste Activated Sludge Pumps	3	10	7.5	2	2,190	32,850	0.25%
Disinfection System	1		130	1	4,380	569,400	4.38%
Final Effluent Peak Pumps	4	100	74.6	1	350	26,110	0.20%
Primary Sludge Thickening	4	10	7.5	4	350	10,500	0.08%
Anaerobic Digester Circulation Pumps	4	15	11.2	4	8,760	392,448	3.02%
Anaerobic Digester Mixing	6	10	7.5	4	8,760	262,800	2.02%
Belt Press	1	0	7.5	1	2,920	21,900	0.17%
Odor Control	1	50	37.3	1	8,760	326,748	2.52%
Effluent Reuse Pumps	1	10	7.5	1	4,380	32,850	0.25%
Sludge Transfer Pumps	2	20	14.9	1	2,080	30,992	0.24%
WWTF Compressed Air System	2	30	22.4	1	8,760	196,224	1.51%
<b>ENTIRE FACILITY ENERGY</b>					<b>TOTAL =</b>	<b>12,987,507</b>	<b>kWh/yr</b>
					<b>@10 MGD =</b>	<b>3,650</b>	<b>MG/yr</b>
					<b>BASELINE =</b>	<b>3,558</b>	<b>kWh/MG</b>

# Understanding Your Electric Bill

## APPENDIX B

### GET TO KNOW YOUR BILL

Attached are sample electric bills. One is for a large wastewater treatment facility and the other is for a small wastewater treatment facility. These examples show the information and data that electric bills provide and help you better understand their terms and definitions. Note that in the examples the demand charges (kW) represent between 30 and 40 percent of the total monthly bill. This is usually an area that can be reduced and provide substantial savings.

### SUGGESTIONS FOR MANAGERS AND OPERATORS

1. Get a copy of your monthly bill and review it to understand the information it provides.
2. Contact and get to know the energy provider account representative for your facility.
3. Determine what rate schedule your energy provider has applied to your facility.
4. Meet with your account representative to assess if this rate schedule is the most appropriate one for your facility. Ask if they can provide on-line, real-time monitoring of your energy use. Request a graph of your 15-minute demand values so you can see when peak demands occur.
5. Develop a delivery and review procedure that provides the facility with a copy of the monthly bill and includes staff review of the monthly bill.
6. Plot energy bill data graphically to help you visualize trends in your facility's energy use.
7. Develop an energy monitoring program to track energy consumed by your major process equipment. See this Energy Guidebook's Best Practices for information about energy use tracking and peak management.

### PUT POWER INTO THE HANDS OF OPERATORS AND MANAGERS

By encouraging and, if feasible, even requiring facility managers and operators to review and understand their electric bills, management of a water and wastewater utility can empower those who may have the best understanding of how to reduce energy and demand charges. Many low- and no-cost operational changes can be easily implemented to lower electric costs, such as turning lights off in unoccupied areas, repairing inoperative exterior lights, and shifting operations to avoid or reduce monthly demand peaks.

Understanding what affects your bill is the first step in managing and reducing your energy costs. The following list provides definitions of the terms you will usually find on your bill.

## ELECTRIC BILL DEFINITIONS

1. **Total Energy** – all energy (kWh) used in billing period.
2. **On Peak Energy** – all energy (kWh) used during peak hours (generally M-F 09:00 to 21:00\*)
3. **Off Peak Energy** – all energy (kWh) used outside of peak hours
4. **Reactive Energy** – all kVars used during peak hours (used to calculate power factor)\*\*
5. **Demand Actual** – highest kW demand during peak hours
6. **Billable Demand** – highest kW demand during the last 12 months, also called customer demand
7. **On Peak kW Demand** – highest kW demand during peak hours, also called actual demand
8. **Adjusted On Peak Demand** – On Peak kW Demand adjusted for power factor
9. **Billable On Peak Demand** – same as Adjusted On Peak Demand
10. **Off Peak Demand** – highest kW demand during the off-peak hours
11. **Billable Off Peak Demand** – not used in Wisconsin
12. **Power Factor On Peak Demand** – calculated average power factor during peak hours\*\*\*
13. **Customer Charge** – monthly flat fee for administration, meter reading, billing, etc. Amount varies based on rate class (size and sophistication of service)
14. **Peak kWh Energy Use Charge** – charge for energy used during peak hours (generally M-F 09:00 to 21:00)\*
15. **Off Peak kWh Energy Use Charge** – charge for energy used outside of peak hours
16. **Energy Charge Credit kWh** – all kWh in excess of 400 hours X on-peak billing demand\*\*\*\*
17. **Customer Demand** – highest kW demand during last 12 months
18. **On Peak Demand** – highest peak kW demand during billing period
19. **Low-Income Assistance** – a Wisconsin state-mandated fixed fee†
20. **Processing Charge** – one-time charge for new account setup
21. **Heating Degree Days** – how much lower than average the daily temperature is compared with a base of 65 degrees Fahrenheit. The average daily temperature is subtracted from 65 degrees. The higher the Heating Degree Days, the more your heating system needs to run.
22. **Cooling Degree Days** – how much higher than average the daily temperature is compared with a base of 65 degrees Fahrenheit. Subtract 65 degrees from the average daily temperature. The higher the Cooling Degree Days, the more your air conditioning system needs to run.
23. **The number of workweek days** (M-F) during the billing period (in this example, 22 days)
24. **The number of calendar days** during the billing period (in this example, 30 days)

\*Note that the on-peak time frame is established by your electric utility. Consult your electric account manager to identify your on-peak time frame.

\*\*Reactive energy – amount of kilo-vars (kVar) used in billing period. Reactive power is delivered from the generator source and used by equipment with core/coil assemblies to develop magnetic fields. Reactive power does not provide any mechanical work like real power (kW) does, but still contributes to the amount of kVar or the “apparent power.”

\*\*\*Power factor (PF) is the ratio of real power to apparent power. The average on-peak power factor is defined to be the quotient obtained by dividing the on-peak kWh used during the month by the square root of the sum of the squares of the on-peak kWh used and the lagging reactive kilovolt-ampere-hours supplied during the same on-peak period. When the average on-peak power factor is less than 90%, the power factor adjustment for billing is 90% divided by the average on-peak power factor (expressed in percent).

\*\*\*\*Not to exceed 50 percent of total kWh times \$0.01/kWh. 400 hours based on a 30-day billing period.

†In 2006, the Wisconsin Legislature passed Act 141, which requires electric utilities to collect a fee from their customers to help fund low-income energy assistance programs. These funds are collected through the WI Low-Income Assistance Fee—previously known as the Non-Taxable Customer Charge—and then transferred to the Wisconsin Department of Administration to assist low-income customers.

## UNDERSTANDING YOUR BILL - SMALL BILL



Wisconsin Public Service Corporation

ACCOUNT NUMBER	DATE DUE	PLEASE PAY
[REDACTED]	08/13/2015	\$2,219.53
		AMOUNT PAID

6



WISCONSIN PUBLIC SERVICE  
PO BOX 19003  
GREEN BAY WI 54307-9003



Please fold on perforated line, detach and return this portion with your payment.

Wisconsin Public Service  
PO BOX 19003  
GREEN BAY WI 54307-9003

Visit us on the Web  
[www.wisconsinpublicservice.com](http://www.wisconsinpublicservice.com)

Call 877-444-0888  
7 AM-5 PM Mon-Fri

CUSTOMER NAME AND ADDRESS	ACCOUNT	BILL DATE	NEXT READ
[REDACTED]	[REDACTED]	07/23/2015	08/24/2015

### Conservation Information 06/24/2015 to 07/23/2015

	KWH USED	DAYS	KWH/DAY	HTG DEG DAYS <sup>21</sup>	KWH HTG DEG DAY	CLG DEG DAYS <sup>22</sup>	KWH CLG DEG DAY
This Year	24160	30	805.3	49	493.1	70	345.1
Last Month	22560	32	705.0	193	116.9	12	1880.0
Last Year	23360	31	753.5	56	417.1	73	320.0

### Statement of Your Account

	Beginning Amount	.00
<b>ELECTRIC</b>	Energy Charges/Credits	1,165.98
	Monthly Charges	130.61
	System Demand Charges	794.58
	Customer Demand Charges	128.36
	<b>Total Amount Due 08/13/2015</b>	<b>\$ 2,219.53</b>

## UNDERSTANDING YOUR BILL - SMALL BILL



Wisconsin Public Service Corporation

Detailed Explanation			
<b>COMM IND TOU ELEC SEC</b>			
<b>Cg-20</b>			
Meter No. [REDACTED]	Reading 07/23/2015		4504
	Reading 06/23/2015		- 4202
			302
	Meter Constant		x 80 .00000
	KWH Used		24,160
<b>Energy Charges/Credits</b>			
<b>2</b>	On Peak	7,760 KWH at \$.06591	511.46
<b>3</b>	Off Peak	16,400 KWH at \$.03991	654.52
	Total Energy Charges/Credits		1,165.98
<b>13</b>	Monthly Charges	Daily Cust Chg(30 Days at \$3.0575)	91.73
		WI Low-Income Assistance Fee	8.87
		WI Low-Income Assistance Fee	30.01
	Total Monthly Charges		130.61
<b>System Demand</b>			
<b>14</b>	Peak	60 KW x \$13.243 (22 Days)	794.58
	Base	48 KW x \$.00 (22 Days)	
	Standby Demand	0 KW x \$2.251 (22 Days)	
	Total System Demand		794.58
<b>17</b>	Customer Demand	12 Month Maximum Demand	
		76 KW x \$1.669 (30 Days)	128.36
	Total Customer Demand		128.36
<b>Total Electric Charges</b>			<b>2,219.53</b>
STATEMENT SUMMARY FOR ACCOUNT [REDACTED]			
	Previous Balance 06/23/2015		\$1,939.78
	Payment 07/20/2015		\$1,939.78CR
	Beginning Amount		\$.00
	Electric Service		\$2,219.53
<b>Total Amount Due 08/13/2015</b>			<b>\$2,219.53</b>

## UNDERSTANDING YOUR BILL - LARGE BILL



MAILING ADDRESS		ACCOUNT NUMBER		DUE DATE
[REDACTED]		[REDACTED]		09/21/2015
		STATEMENT NUMBER	STATEMENT DATE	AMOUNT DUE
		[REDACTED]	09/01/2015	\$28,643.97

SERVICE ADDRESS: **Primary Elec Svc LOAD PROFILE**

NEXT READ DATE: [REDACTED]

### ELECTRICITY SERVICE DETAILS

PREMISES NUMBER: [REDACTED]

INVOICE NUMBER: [REDACTED]

### METER READING INFORMATION

METER 4912279 - Multiplier x 1800

Read Dates: 07/21/15 - 08/17/15 (27 Days)

DESCRIPTION	CURRENT READING	PREVIOUS READING	MEASURED USAGE	BILLED USAGE
1 Total Energy	2060 Actual	1876 Actual	184	331200 kWh
2 On Pk Energy	748 Actual	676 Actual	72	129600 kWh
3 Off Pk Energy	1312 Actual	1200 Actual	112	201600 kWh
4 Reactive Energy	366 Actual	329 Actual	37	66600 kVArh
5 Demand	Actual			684 kW
6 Billable Demand				810 kW
7 On Pk Demand	Actual			684 kW
8 Adjusted On Pk Demand				692 kW
9 Billable On Pk Demand				692 kW
10 Off Pk Demand	Actual			666 kW
11 Billable Off Pk Demand				666 kW
12 Power Factor On Pk Demand	88.94%			

193 Cooling Degree Days

### ELECTRICITY CHARGES

RATE: Large TOD Service

DESCRIPTION	USAGE UNITS	RATE	CHARGE
13 Customer Charge			\$155.00
14 On-Peak Energy ChSumme	129600 kWh	\$0.080899	\$10,484.51
15 Off-Peak Energy CSummer	201600 kWh	\$0.047657	\$9,607.65
16 Energy Chg Cred	82080 kWh	-\$0.010000	-\$820.80 CR
17 Customer Demand	810 kW	\$1.120000	\$907.20
18 On-Peak Demand ChSumm	692 kW	\$11.420000	\$7,902.64
<b>Subtotal</b>			<b>\$28,236.20</b>
19 WI Low Income Assist			\$140.00
<b>Total</b>			<b>\$28,376.20</b>

### NON-RECURRING CHARGES / CREDITS DETAILS

DESCRIPTION	CHARGE
20 Processing Charge	\$16.50
<b>Total</b>	<b>\$16.50</b>

**Premises Total**

**\$28,392.70**

DAILY AVERAGES	Last Year	This Year
Temperature	71° F	72° F
Electricity kWh	771.4	12266.7
Electricity Cost	\$184.29	\$1,051.58

THIS PAGE INTENTIONALLY LEFT BLANK



# Economic Evaluation Process

## APPENDIX C

When determining whether an energy efficiency project will be cost effective, most municipalities will apply a simple payback (SPB) approach rather than a life-cycle cost (LCC) approach. Typically, the SPB method is appropriate for smaller projects involving equipment replacement and/or low up-front capital costs with low maintenance costs. However, for larger projects with significant up-front capital costs, multiple cost factors (e.g. maintenance, energy, replacement) and variations in annual cash flow, LCC analysis is more appropriate.

### SIMPLE PAYBACK



The SPB method calculates the amount of time it takes for the cumulative energy savings and other project benefits to break even the initial project investment. To calculate the SPB, divide the total project cost by the total expected benefit.

$$\text{SPB (years)} = \text{Cost of project (\$)} / \text{Annual savings (\$ per year)}$$

**Example:** A facility is evaluating to replace its motors with more efficient models. If the new motors cost \$200,000 and are expected to reduce energy costs by \$100,000 per year and last several years, the SPB is two years ( $\$200,000 / \$100,000/\text{year} = 2 \text{ years}$ ).



## LIFE-CYCLE COST

According to the U.S. Department of Energy (energy.gov), “Life-cycle cost analysis is the process of calculating whether a particular investment... will generate a positive return on investment (ROI) over the life of the technology.”

A very simple LCC analysis<sup>1</sup> takes the value of a project’s stream of benefits over the lifetime of the project and compares it directly with the project’s initial capital cost. The stream of benefits is equal to the sum of the annual energy savings over the lifetime of the project. The LCC approach is used to compare the net value of one option against that of another. Options may include different energy efficient choices and/or simply continuing to operate the existing equipment.

$$\text{NPV} = \Sigma(\text{annual energy savings}) - \text{Initial investment}$$

Where:

$$\Sigma(\text{annual energy savings}) = (\text{Energy use}_{\text{base}} - \text{energy use}_{\text{efficient}}) \text{Year1} + (\text{Energy use}_{\text{base}} - \text{energy use}_{\text{efficient}}) \text{Year2} \dots$$

and:

Energy use<sub>base</sub> = annual energy used by the base option

Energy use<sub>efficient</sub> = annual energy used by the energy efficient option

This analysis should be done for each option being considered. If other factors, which may include non-energy benefits and costs, are not sufficient to outweigh the net value of the highest value option, that option should be selected.



<sup>1</sup> For the sake of simplicity, the illustration does not include interest rates or discount rates to arrive at a better approximation of the Net Present Value (NPV) of a stream of discounted benefits or costs. Benefit and/or cost streams are assumed to be constant over time. A more complex and accurate LCC analysis would calculate the discounted benefits and costs over time to account for the time value of money, whether invested (as energy efficiency savings) or capitalized through loan payments for capital equipment. Additional factors that influence the operation of the technology, such as maintenance, service costs, and materials could also be quantified and included for a more accurate analysis.

## EXAMPLE

Assume that a wastewater utility is considering replacing its worn out aeration equipment with energy efficient fine-bubble diffusers. Compare the utility's three options:

### A: Replace equipment with equipment of the same efficiency as the existing (Base)

Project cost = \$350,000  
 Savings = 0 kWh  
 Energy savings = \$0/year

$$SPB_{\text{base}} = 0 \text{ years}$$

$$\text{Net Value}_{\text{base}} = [ \$0/\text{year} \times 10 \text{ years} ] - [ \$350,000 ]$$

$$\text{Net Value}_{\text{base}} = - \$350,000 \text{ (note that this is a negative value, or a net cost)}$$

### B: Replace equipment with energy efficient alternative.

Project cost = \$600,000  
 Savings = 1,800,000 kWh  
 Energy savings = \$90,000/year  
 Equipment life = 10 years

$$SPB_{\text{Alt B}} = [ \$600,000 / \$90,000 ] = 6.7 \text{ years}$$

$$\text{Net Value}_{\text{Alt B}} = [ \$90,000/\text{year} \times 10 \text{ years} ] - [ \$600,000 ]$$

$$\text{Net Value}_{\text{Alt B}} = \$300,000$$

### C: Replace existing equipment with the best practice energy efficient alternative.

Project cost = \$750,000  
 Savings = 2,100,000 kWh  
 Energy savings = \$110,000/year  
 Equipment life = 10 years

$$SPB_{\text{Alt B}} = [ \$750,000 / \$110,000 ] = 6.8 \text{ years}$$

$$\text{Net Value}_{\text{Alt B}} = [ \$110,000/\text{year} \times 10 \text{ years} ] - [ \$750,000 ]$$

$$\text{Net Value}_{\text{Alt B}} = \$350,000$$

## DISCUSSION

From the table, below, it can be seen that Option A (doing nothing) has a zero payback, but in the long term it loses out to Options B and C which provide a stream of benefits that help to pay for the entire project. It can also be seen that, while Option B has a shorter payback than Option C, the life-cycle cost benefits of Option C have a \$50,000 advantage over Option B. For a measure that has a projected lifetime of 10 years, Option C is the best choice because it has the highest LCC benefit.

Option	SPB	LCC	Net Value (from Base A)
A	Base (0)	-\$350,000	Aerated Lagoon
B	6.7 yrs	+\$300,000	Aerated Lagoon
C	6.8 yrs	+\$350,000	Aerated Lagoon

## NET PRESENT VALUE

The Net Present Value (NPV) of an energy project or investment shows the degree to which savings equal or exceed the amount of investment needed to fund the energy project. When assessing multiple projects, NPV is a way to compare cash flow to ensure that only the most lucrative ventures are pursued. A higher NPV means that the project or investment is more cost-effective. According to Wikipedia:

*“The net present value (NPV) or net present worth (NPW) is defined as the sum of the present values (PVs) of incoming and outgoing cash flows over a period of time. Incoming and outgoing cash flows can also be described as benefit and cost cash flows, respectively .... NPV is determined by calculating the costs (negative cash flows) and benefits (positive cash flows) for each period of an investment.”*

For the sake of illustration, the following NPV table shows the stream of benefits for Option C, assuming 4% APR on a 10-year bond to capitalize \$750,000 for the project. Annual payments are \$92,468 (Column A). Annual energy savings have been discounted by 1% per year (Column C). In this example, note that the NPV, by year, shows a positive cash flow, i.e. the energy savings always exceed the loan payments. Over the 10 year expected life of the equipment, the cumulative net benefits are \$79,000, compared with making no changes to the facility. Always consult your accountant or bank when conducting this type of analysis. Your estimates of energy savings should rely on sound engineering expertise.

Year	A Annual Loan Payments	B Cumulative Loan Payments	C Discounted Energy Savings	D Cumulative Present Value of Energy Savings	E Net Present Value by Year (C – A)	F Cumulative Net Present Value
0	0	0	0	0	0	0
1	92,468	92,468	110,000	110,000	17,532	17,532
2	92,468	184,936	108,900	218,900	16,432	33,964
3	92,468	277,404	107,811	326,711	15,343	49,307
4	92,468	369,872	106,733	433,444	14,265	63,572
5	92,468	462,340	105,666	539,109	13,198	76,769
6	92,468	554,808	104,609	643,718	12,141	88,910
7	92,468	647,276	103,563	747,281	11,095	100,005
8	92,468	739,744	102,527	849,808	10,059	110,064
9	92,468	832,212	101,502	951,310	9,034	119,098
10	92,468	<b>924,680</b>	100,487	<b>1,051,797</b>	8,019	<b>127,117</b>

## ADDITIONAL REFERENCES

The US Environmental Protection Agency (EPA) Energy Star Tools and Resources Library provides links to various Financial Evaluation Tools, including a Cash Flow Opportunity Calculator (a Microsoft Excel-based tool) to help decision-makers evaluate the benefits of installing energy-efficient equipment.

- ([http://www.energystar.gov/index.cfm?c=tools\\_resources.bus\\_energy\\_management\\_tools\\_resources](http://www.energystar.gov/index.cfm?c=tools_resources.bus_energy_management_tools_resources))

The US Department of Energy's Federal Energy Management Program (FEMP) offers many resources to assist with Life-Cycle Cost Analysis including FEMP's Building Life-Cycle Cost Software, training opportunities and a Life Cycle Costing Manual.

Additional resources can be found on the following websites:

- (<http://www1.eere.energy.gov/femp/program/lifecycle.html>)
- <http://simple.werf.org/simple/media/LCCT/examples.html>
- <http://www.nyserda.ny.gov/Communities-and-Governments/Communities/Municipal-Water-and-Wastewater/MWWT-Tools-and-Materials>
- <http://www.gsa.gov/portal/content/101197>
- <http://energy.gov/sites/prod/files/2014/10/f18/LCC%20Handbook%20Final%20Version%209-30-14.pdf>

THIS PAGE INTENTIONALLY LEFT BLANK

# Small Utility Energy Management Checklists

## APPENDIX D

This appendix includes two checklists, one for water utility systems and the other for wastewater utility systems, which are smaller than the average utility. The checklists are intended to provide an easy way for a system operator to gather the important data that will help the utility in developing an energy plan to manage their energy costs. In addition, each checklist can be completed and submitted to Focus on Energy for additional support in implementing energy projects. Each checklist is accompanied by a Checklist Guidance section to assist in the completion of the checklists.

The Focus on Energy checklists were modified from the original checklists developed in coordination with the Consortium for Energy Efficiency (CEE), using the CEE templates as the basis.

The checklists included are:

- Small Drinking Water Treatment Facility Energy Efficiency Opportunity Checklist
- Small Wastewater Facility Energy Efficiency Opportunity Checklist

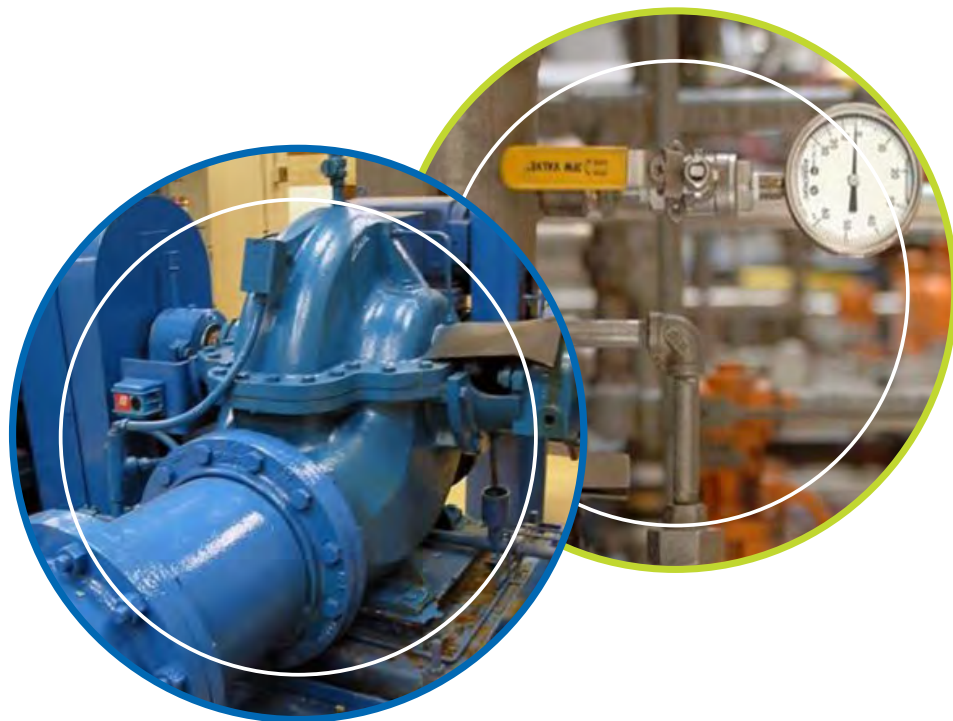

## SMALL DRINKING WATER TREATMENT FACILITY ENERGY EFFICIENCY OPPORTUNITY CHECKLIST

**HOW TO USE THIS CHECKLIST:** Energy costs are a significant and growing burden on operating budgets at small treatment facilities nationwide. At small water treatment facilities this energy use is typically concentrated in the pumping and disinfection systems. Use this Checklist to highlight potential energy savings at your facility. Then contact the Focus on Energy Program with your results to learn how your facility can start saving energy and money, and what incentives and other resources your local program has to offer.

**DISCLAIMER:** This Checklist is an informational tool. Submitting the completed Checklist to Focus on Energy entails no commitment on the part of yourself or your facility to make process or operations changes. Consult with a professional engineer prior to making process changes that may impact drinking water quality or public health. This Checklist was developed by CEE with help from engineering professionals.



1. Treatment and Distribution Information	Wells	Pumped Surface Water	Gravity Surfaced Water
Please provide plant flow rates for all water sources at design, peak, and winter average conditions.			
Design			
Peak			
Winter Average			

Treatment Process	Slow Sand	Package Filtration	Mixed Media	Membrane Filtration	Other
Check all that apply					



Pump Use Within Your System	HP Total	HP Operating	Annual Hours	Control
Provide information on pump use within your system, by pump type (well, raw/finished water pumps, booster pumps, backwash pumps). For each type please provide total pump horsepower, horsepower usually operating, annual hours of use, and method used to control pump output, if any (e.g. recirculation, throttling, variable speed drive).				
Raw Water				
Finished Water				
Booster				
Backwash				
Well #1				
Well #2				
Well #3				

2. Pumping Information	Yes	No	Comments
Are any of the listed pumps not operating at their design flow and head?			
If any of the listed pumps are throttled, how much are they throttled?			
Are any of the listed pumps not operating at their design flow and head?			
Do you pump from a well to an at-grade reservoir and then pump again to a tower?			
Are your finished water pumps operated mainly during off-peak electric hours?			
3. Treatment Process	Yes	No	Comments
Do you use membrane or pressure filtration?			
Do you use backwash pumps?			
Do you use an ultraviolet (UV) disinfection system?			
If yes, does the UV system use low-pressure, high-output lamps?			
Do you use reverse osmosis for treatment?			
Do you use centrifuges for dewatering residuals?			

4. Booster Pumping - Reservoir to Reservoir	Yes	No	Comments
Do you have booster pumping stations to move water from one reservoir to another? (Include # of stations, # of pumps, and total hp at each station).			
If yes, are any of these pumps not operating at their design flow and head?			
Are any of these pumps throttled to adjust flow rate?			
Do these pumps have variable speed control? If yes, please explain.			
5. Booster Pumping - Reservoir to Closed System	Yes	No	Comments
Do you have booster pumping stations that move water from one storage reservoir to a pressure zone without a storage reservoir? (Include # of stations, # of pumps, and total hp).			
If yes, are any of these pumps allowed to run continuously without controls?			
Are any of these pumps throttled to adjust flow rate?			
Do any of these pumps have variable speed control?			
Are any of these pumps sized to meet maximum daily flow (vs. avg. day flow)?			
In your distribution system, do any pressure zones operate at pressures greater than 65 psi? (Please provide operating pressure and reason necessary).			
6. Other	Yes	No	Comments
Has your plan undergone any energy improvement projects in the past five years?			
Is or will your plant be undergoing renovation to comply with permitting requirements or to meet capacity needs?			
If yes, are energy conservation measures included as part of this renovation?			
Do you have a backup generator capable of powering your facility?			
Do you have a computer model of your distribution system?			
Does your system have elevated storage?			
Does your system have pressure relief valves to transfer water between pressure zones?			
In which WDNR District are you located? _____			

Contact Information	
Your Name:	
Facility Name:	
Facility Address:	
Email Address:	
Phone Number:	
Do you have any ideas or plans that could improve the energy efficiency of your system?	



## DRINKING WATER CHECKLIST GUIDANCE

The guidance below corresponds to a particular question or questions on the Water Checklists. This information provides insights into possible energy saving opportunities, and identifies the information that program staff should collect.

### GENERAL SYSTEM INFORMATION

- System information is provided as a diagnostic overview, to provide program staff with an overall view the system. The answers to the checklist are not themselves intended to indicate energy savings opportunities, but to inform program staff as to the likely size or prevalence of an energy efficiency opportunity.

### IN-PLANT PUMPING

- 2B. An answer that a pump is not operating at its design flow and head is an indication of some degree of an energy savings opportunity. Follow-up should determine how far off of design flow and head the pump is operating, the reason why the pump is operating off its design point, and how many and how large are the pumps for which this is the operating condition.
- 2C. An answer indicating that a pump is throttled indicates a likely energy savings opportunity. The size and number of those pumps are critical variables in determining the achievable savings.
- 2D. Variable speed drives (VSDs) may yield energy savings on raw and finished water pumps. Identify whether pumping loads are constant or variable, and whether greater savings might be achieved through right-sizing pumps to meet average and peak pumping demands.
- 2I. If finished water pumps are not operated mainly during off-peak hours, this may indicate an opportunity for load shifting. Not using existing in-system storage may indicate a similar opportunity. Determine if storage exists and if it is being used effectively.

## TREATMENT PROCESS

- 3A. Membrane filtration is the most energy intensive commonly-found water treatment process type, because pumping is required to move water through the membrane and blower air is required to clean the membrane.
- 3B. Backwash pumps may present opportunities for energy savings if they are throttled during backwash operation. Determine if a variable speed drive is warranted by estimating percent throttling and the total backwash pump operating hours per year.

## BOOSTER PUMPING—RESERVOIR TO RESERVOIR

- 4B. See “In-Plant Pumping”, above, for operational control.
- 4D. Pumping with variable speed drives (VSD) from reservoir to reservoir is less energy efficient than pumping at full speed if that is the pump’s most efficient operating point. Assess if whether the VFDs can be removed or if pump combinations operating at their most efficient points on the curve can be selected via automatic controls for meeting average and peak flow conditions.

## BOOSTER PUMPING—RESERVOIR TO CLOSED SYSTEM

- 5B. Operating a pump continuously without controls wastes energy as the pump moves up and down its performance curve to meet changing pressure and flow demands. For pumping from Reservoir to Closed System, a VSD controlled by pressure setting is the most efficient method, provided multiple pumps sized individually for average demand and in combination to meet peak demand are provided. Investigate the value of installing VSD control.
- 5E. Pumps sized to meet maximum flow will be oversized for average flows. Determine if the facility should have smaller pumps sized to handle average flows.
- The presence of a backup generator may indicate a demand management opportunity. Determine if any programs or energy utility services are available that can enable peak shaving opportunities.

## SMALL WASTEWATER FACILITY ENERGY EFFICIENCY OPPORTUNITY CHECKLIST

**HOW TO USE THIS CHECKLIST:** Energy costs occupy up to 40 percent of operating budgets at small treatment facilities (WEF 2009), but many facilities could save 20 to 40 percent of the energy they are using through energy efficiency. Use this Checklist to highlight potential energy savings at your facility. Contact Focus on Energy with your results to learn how your facility can start saving energy and money, and what incentives and other resources Focus on Energy has to offer.

**DISCLAIMER:** This Checklist is an informational tool. Submitting the completed Checklist to Focus on Energy entails no commitment on the part of yourself or your facility to make process or operations changes. Consult with a professional engineer prior to making process changes that may impact effluent quality. This Checklist was developed by CEE with help from engineering professionals.



1. Facility in General	Primary	Secondary	Tertiary	Nutrient Removal
Which process types does your facility employ (check all that apply)?				
Which solids processing types does your facility employ (check all that apply)?				

	Design	Current
Please provide your average day design and current flow rates.	MGD	MGD
Please provide your average day design and current organic loading.	lbs BOD/day	lbs BOD/day

	Comments
What is your current electric usage?	kWh/yr
If using blowers, what type and size (hp) of blowers do you use?	

	Yes	No
Is the majority of your motors NEMA Premium® efficiency?		
Do you receive and review the facility's monthly electric and gas bills?		

<b>2. Influent and Effluent Pumping</b>	<b>Yes</b>	<b>No</b>	<b>Comments</b>
Do you have on-site influent or effluent pumps?			
If yes, do you have variable speed control on these pumps?			
Are any of these pumps <u>not</u> operating at design flow head?			
<b>3. Pre- and Post-Aeration</b>	<b>Yes</b>	<b>No</b>	<b>Comments</b>
Do you utilize aeration blowers for pre- or post-aeration, or other aeration uses?			
If yes, are there currently means to adjust the amount of air delivered to each use (describe in box to right)?			
<b>4. Intermediate Pumping</b>	<b>Yes</b>	<b>No</b>	<b>Comments</b>
Do you have intermediate pumps to convey flow from primary to secondary processes, or from secondary to tertiary treatment processes?			
If yes, do you have variable speed control on these pumps?			
Are any of these pumps not operating at design flow head?			
<b>5. Biological Process: Activated Sludge/Aerated Lagoons</b>	<b>Yes</b>	<b>No</b>	<b>Comments</b>
Does your facility use mechanical aerators?			
If yes, do the aerators have variable speed control?			
Are the aerators controlled by a timer?			
Do you utilize aeration blowers as part of the activated sludge process?			
Is the DO level in any of your aeration basins >2.0? If yes, please explain.			
Is your aeration system automatically controlled via DO levels and/or pressure differentials?			
If yes, are DO sensors located within each aeration basin?			
Do you currently use a fine-bubble aeration system?			
Do you have means of detecting diffuser fouling (please describe in box to the right)?			
Do you currently have variable speed RAS pumps?			
Do you currently have variable speed WAS pumps?			
<b>6. Biological Process: Fixed Film (RBCS or Trickling Filters)</b>	<b>Yes</b>	<b>No</b>	<b>Comments</b>
Does your facility use supplemental aeration blowers as part of a fixed film process?			
If yes, are there currently means to automatically adjust the amount of air delivered?			

Do you utilize pumps to convey flow to the trickling filters?			
If yes, do you have variable speed control on these pumps?			
Are your trickling filter distribution arms mechanically driven?			
<b>7. Disinfection</b>	<b>Yes</b>	<b>No</b>	<b>Comments</b>
Do you currently use an ultraviolet (UV) disinfection system?			
If yes, does the UV system utilize low-pressure, high-output lamps?			
Is the system currently operated via flow-pacing and/or dosing set-point based on water quality?			
<b>8. Sludge Pumping</b>	<b>Yes</b>	<b>No</b>	<b>Comments</b>
Does your facility process sludge less than 24 hrs/day?			
Does your sludge handling process have equalization capacity?			
If not, do you have variable speed capability on your sludge transfer pumps?			
Are any of these pumps not operating at design flow and head?			
<b>9. Sludge Stabilization</b>	<b>Yes</b>	<b>No</b>	<b>Comments</b>
Does your facility utilize aerobic digestion?			
If yes, has there been consideration of anaerobic digestion?			
Do you currently have the capability to produce biogas from anaerobic digestion processes?			
If yes, do you practice beneficial reuse of biogas (for process heat, building heat, electric generation)?			
<b>10. Sludge Thickening and Dewatering</b>	<b>Yes</b>	<b>No</b>	<b>Comments</b>
Does your thickening/dewatering equipment run less than 24 hrs/day?			
Do you use centrifuges for thickening, dewatering, or both?			
Do you use sludge drying beds for dewatering?			
Do you haul sludge to another location for processing?			
Do you use incineration for sludge stabilization/disposal?			
<b>11. Other</b>	<b>Yes</b>	<b>No</b>	<b>Comments</b>
Has your facility undergone any energy improvement projects in the past five years?			
Is or will your facility be undergoing renovation to comply with permitting requirements or to meet capacity needs?			
If yes, are energy conservation measures included as part of this renovation?			
Do you have a backup generator capable of powering your facility?			

Contact Information	
Your Name:	
Facility Name:	
Facility Address:	
Email Address:	
Phone Number:	
Do you have any ideas or plans that could improve the operating efficiency of your system?	



## WASTEWATER CHECKLIST GUIDANCE

The guidance below corresponds to a particular question or questions on the Wastewater Checklist. This information provides insight to systems and savings opportunities, and identifies the information that program staff should obtain. The relative size of a given energy savings opportunity is provided for each measure discussed below, on a range from 1 (small) to 3 (significant). The order of questions in the Checklists corresponds roughly to the order of treatment processes at a typical facility.

### GENERAL SYSTEM INFORMATION

- System information is provided as a diagnostic overview. The answers on the checklist are not intended to indicate energy savings opportunities (with the possible exception of 1F Blower Type & Size), but rather to inform Focus on Energy staff as to the likely size or prevalence of an energy project opportunity. An energy advisor will review and assess the information provided, and then utilize the results to identify energy efficiency opportunities.
- 1E. Blower type & size have energy efficiency implications. High-speed, gearless blowers may offer energy savings if used to replace positive displacement or multistage centrifugal equipment. Blower selection and sizing is complex and must be matched to loading and conditions, and should involve consultation with a process engineer. (3)

### PRE- AND POST-AERATION

- 3A. Pre-, post- and channel aeration may provide opportunities to reduce blower energy consumption. Aerated channels typically require air at 2-4 psi, vs. 9-12 psi for aeration basins. Aerated channels that draw air from the primary aeration blowers present a savings opportunity. Follow-up should determine if pre- or post-aeration and aerated channels are necessary and if they can be operated periodically and not continuously. In addition, determine if aerated channels draw from a dedicated blower at lower pressure. If they draw from the aeration blower an energy efficiency opportunity exists. (2)



**BIOLOGICAL PROCESS—ACTIVATED SLUDGE**

- 5A. Mechanical aeration is usually less efficient than blowers and fine bubble diffusers. Equipment replacement may offer significant savings. Equipment refurbishment, typically involving trimming or redesign of the aerator impeller, can also yield significant energy savings, though not as great as from switching to diffused aeration. (3)
- 5B. Variable speed control may offer significant savings for mechanically aerated systems. Follow-up should identify the total hp size of the mechanical aerators, and the current dissolved oxygen set-point for the system. (2)
- 5C. Timer control may offer significant savings if a mechanically aerated system is without variable speed control. Follow-up should determine if the system operates continually without control, and quantify total aeration process energy consumption, or horsepower, and the operating hours per year of each mechanical aerator. (3)
- 5E. Automatic Dissolved Oxygen (DO) set-point control using variable speed drives may provide significant energy savings for aeration blower systems currently operating without automatic controls. Follow-up should obtain blower performance curves and motor sizes to determine the range of efficient operation the blower can provide. Further review should verify what the operating DO levels are and how are they controlled. (3)
- 5G. DO concentration should be measured and controlled in each aeration basin to assure efficient blower air distribution and use. A DO level greater than 2.0 ppm indicates over-aeration and an opportunity to reduce blower energy consumption. Follow-up should determine location of DO probes in the aeration tank(s) used for control and suggest a reduction below 2.0 ppm. Blower turn-down presents an immediate and inexpensive energy management opportunity. (2)
- 5I. Fine bubble diffusers can foul in a matter of months and significantly reduce system efficiency. Regular detection and prevention of diffuser fouling is a common, low-cost energy savings opportunity. Follow-up should include regular diffuser cleaning and maintenance as an immediate, near-term energy savings opportunity. Note that ceramic diffusers are more prone to fouling than flexible membrane diffusers, and typically require more frequent cleaning. (2)

**BIOLOGICAL PROCESS—FIXED FILM**

- 6A-B. Supplemental aeration or drive blowers provide an opportunity to control the weight of the biological growth on the fixed media discs that are being rotated. Automatic weight set-point control reduces energy waste by activating additional aeration to shear the excess biological growth when it becomes too heavy. (2)
- 6C. Test the efficiency of pumps key to determine if replacement with more efficient units is warranted. (2)
- 6E. Trickling filter distribution arms typically operate 8,670 hours per year. In such situations, premium efficiency motors can provide a significant savings opportunity (with short payback) when replacing standard efficiency equipment. Additionally, if loads are intermittent, there may be an opportunity to reduce recycle pumping used to keep the trickling filter wet. Follow-up should determine whether trickling filter loading is constant or variable, and whether there is an opportunity to upgrade distribution arm motor efficiency or retrofit from hydraulic-driven arms to motor-driven arms. (2)

## DISINFECTION

- 7B. Low pressure, high output lamps offer savings over standard UV lamps. The amount of savings will vary with the number of lamps and operating hours. Follow-up should determine lamp type and operating hours, in order to estimate savings potential. (2)
- 7C. Controlling UV dosage via flow-pacing or turbidity can offer savings over continuous high dose operation. In order to assess the impact of improved controls, follow-up should establish how the system is controlled and the average UV system run-times. (2)

## SLUDGE STABILIZATION

- 9A. Aerobic digestion may present an opportunity to convert to facultative digestion through reduced aeration regulated by ORP (oxidation reduction potential), or to anaerobic digestion with biogas reuse. Review and assess the feasibility of process changes. (3)
- 9C. A facility that employs anaerobic digestion but does not reuse the biogas likely presents a significant energy savings or renewable energy generation opportunity. Assess the quantity and quality of the biogas produced and whether previous attempts at beneficial reuse have been made. (3)

## SLUDGE THICKENING & DEWATERING

- 10B. Replacing centrifuges used for thickening/dewatering with gravity belt press or other equipment may offer significant energy savings. Determine total solids processed per day and energy consumed by the system. (2)
- 10E. Incineration may provide an opportunity for heat recovery and energy production. Determine the feasibility and estimate the cost savings (sludge removal) and energy generation potential of incineration. (2)

# Additional Resources

# APPENDIX E

## PUBLICATIONS

1. *American Water Works Association – Energy Management for Water Utilities*, American Water Works Association, to be printed 2016.
2. *Electricity Use and Management in the Municipal Water Supply and Wastewater Industries 3002001433*, Electric Power Research Institute, November 2013.
3. *Ensuring a Sustainable Future: An Energy Management Guidebook for Wastewater and Water Utilities*, U.S. Environmental Protection Agency, 2008.
4. *The Wastewater Treatment Plant Pumps: Guidelines for Selection, Application, and Operation Guidebook*, Hydraulic Institute, 2015.
5. *Water Environment Federation Manual of Practice No. 32 – Energy Conservation in Water and Wastewater Treatment Facilities*, Water Environment Federation, 2009.
6. *Water Environment Research Federation – The Energy Roadmap: A Water and Wastewater Utility Guide to More Sustainable Energy Management*, Water Environment Research Foundation, 2013.

## WEBSITES

- American Council for Energy Efficient Economy (ACEEE) - <http://aceee.org/>
- American Society of Heating, Refrigerating and Air-Conditioning Engineers (ASHRAE) - <http://www.ashrae.org>
- American Water Works Association - <http://www.awwa.org/>
- Electric Producers Research Institute - <http://www.epri.com/Pages/Default.aspx>
- Hydraulic Institute/Pump Systems Matter - <http://www.pumps.org/>
- New York State Energy Research and Development Authority (NYSERDA) Focus on Water and Wastewater – <http://water.nyserda.org>

- U.S. Department of Energy – <http://www1.eere.energy.gov/industry/bestpractices/software.html>
- U.S. Environmental Protection Agency’s ENERGY STAR® Portfolio Manager Platform – [http://www.energystar.gov/index.cfm?c=eligibility.bus\\_portfoliomanager\\_eligibility](http://www.energystar.gov/index.cfm?c=eligibility.bus_portfoliomanager_eligibility)
- U.S. Green Building Council – <http://www.usgbc.org>
- Water Research Foundation – <http://www.werf.org/>
- Wisconsin Department of Natural Resources - Operator Certification – <http://dnr.wi.gov/regulations/opcert/>
- Wisconsin Department of Natural Resources – Wastewater – <http://dnr.wi.gov/topic/wastewater/>
- Wisconsin Department of Natural Resources – Water – <http://dnr.wi.gov/topic/drinkingwater/>

## ORGANIZATIONS AVAILABLE FOR MORE INFORMATION



- Wisconsin Wastewater Operators Association (WWOA) – <https://www.wwoa.org/>
- Wisconsin Rural Water Association (WRWA) – <http://www.wrwa.org/>
- Environmental Protection Agency Region 5 (EPA) – <http://www2.epa.gov/aboutepa/epa-region-5>
- Wisconsin Water Association (WWA) – <http://www.wiawwa.org/>
- Wisconsin Focus on Energy – <https://focusonenergy.com/>
- Your energy provider



